

Litton

Marine Systems

Sperry
Marine

DECCA

 **C. PLATH**

Operator, Technical, Installation and Service Manual

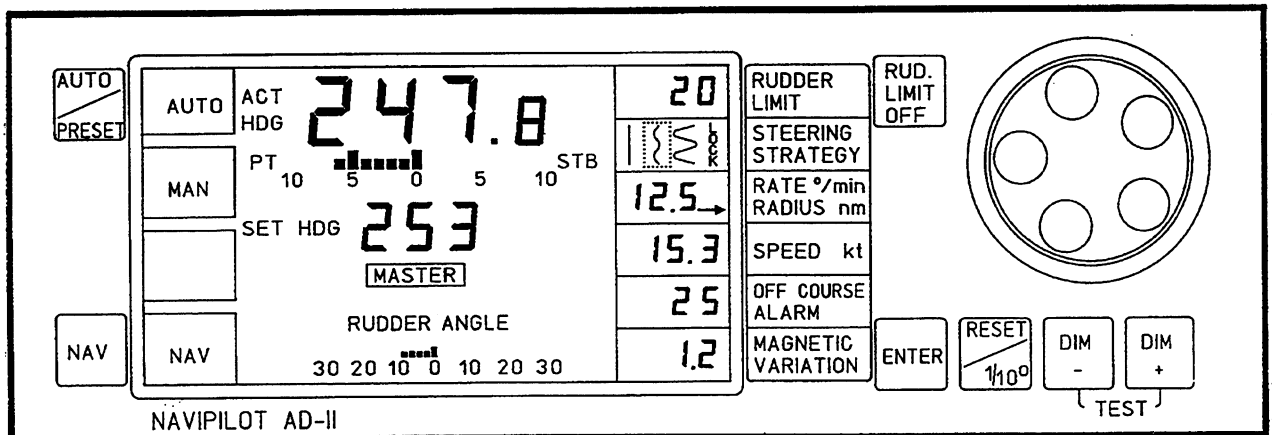

NAVIPILOT AD II / LMP STA

Self-Tuning Adaptive Autopilot System

15 MAR 99 REV J

Stock No.056220

Printed in Germany

8-132 Pilot-AD.PM5

C. PLATH

Head Office and Freight: Stueckenstrasse 1-3, D-22081 Hamburg, Germany

Correspondence Address: P.O. Box 76 08 60, D-22058 Hamburg, Germany

Tel. ++ 49 - 40 - 299 00-0, Fax ++ 49 - 40 299 00-298, Telex 2 15 202 a plat d, E-mail: HDR@GW.LITEF.DE



C. PLATH
NAVIGATION · AUTOMATION

Copyright © C. PLATH, Hamburg 1996

This document contains proprietary information of C. PLATH in Hamburg, Germany.

Any use, reproduction or publication of this manual or any portions thereof for purposes other than operation and maintenance by the recipient is expressly prohibited without the prior written consent of C. PLATH. Subject to alteration without notice.

* * *

Die in diesem Handbuch enthaltenen Angaben sind Eigentum der Firma C. PLATH in Hamburg, BRD.

Der Gebrauch, die Vervielfältigung oder die Veröffentlichung dieses Handbuches in der Gesamtausgabe oder in Auszügen zu anderen Zwecken als der Bedienung und der Wartung durch den Empfänger, ist nur mit vorheriger schriftlicher Genehmigung der Firma C. PLATH gestattet. Technische Änderungen vorbehalten.

* * *

Les données contenues dans cette brochure sont propriété de l'entreprise C. PLATH de Hambourg.

Toute utilisation, reproduction ou publication de cette brochure, soit en totalité, soit sous forme d'extraits, à toute autre fin que le service et l'entretien du matériel par le destinataire, n'est autorisée qu'après accord écrit de la société C. PLATH. Sous réserve de modifications techniques.

* * *

Los datos que contiene este manual se refieren a la propiedad de la firma C. PLATH en Hamburgo.

El uso, la reproducción o la publicación de este manual en su total o en parte para otros motivos que no sean ni de servicio ni de mantenimiento es prohibido sin un permiso escrito especial de la firma C. PLATH. Modificaciones técnicas son reservadas.



List of Contents

CHAPTER/ SECTION		PAGE
1.	DESCRIPTION	1-01
1.1	Task of the Adaptive Autopilot	1-01
1.2	Function	1-03
1.3	Technical Data	1-04
2.	OPERATION	2-01
2.1	Foreword	2-01
2.2	General	2-01
2.3	Controls	2-02
2.4	Storing Parameters	2-03
2.4.1	General	2-03
2.4.2	Steering Parameter Selection Procedure	2-04
2.5	The Effects and Uses of the Steering Parameters	2-06
2.5.1	Rudder Limit and Rudder Limit Off	2-06
2.5.2	Steering Strategy	2-06
2.5.3	Rate and Radius	2-08
2.5.4	Speed Input	2-08
2.5.5	Off Course Alarm	2-08
2.5.6	Magnetic Variation	2-09
2.6	Preset Heading	2-09
2.7	Switchover to Autopilot Control	2-10
2.8	Synchronization of the Autopilot ACTual HeaDinG Display with the Heading of the Gyrocompass (serial interface C.PLATH or NMEA)	2-10
2.9	Synchronization of the Autopilot ACTual HeaDinG Display with the Heading of the Gyrocompass (6 steps and synchro outputs)	2-10
2.10	Override Function	2-10
2.11	Display of the Current Software Revision Number	2-11
3.	INSTALLATION AND INITIALIZATION	3-01
3.1	General	3-01
3.2	Before Installation	3-01
3.3	Installation	3-02
3.4	After Installation	3-02
3.5	Setup Procedure	3-03
3.6	The Setup Table	3-17
3.7	The Tau Nomogram	3-20
3.8	Adaption Procedure with Gyrocompass Systems	3-23
3.9	Adaption Procedure with Magnetic Compass Systems	3-26
3.10	Display of Software Version	3-28
3.11	Autopilot Error Codes	3-29
3.12	Power-Up Test	3-31
3.13	Correction Table for the Heading from the Magnetic Compass	3-33



CHAPTER/ SECTION	PAGE
4. VOYAGE DATA RECORDER	4-01
4.1 General	4-01
4.2 Operational Data	4-01
4.3 Paper Feed Speeds and Rudder Angle Ranges	4-02
4.3.1 60 mm/h Paper Feed Speed, $\pm 45^\circ$ Rudder Angle Range	4-02
4.3.2 150 mm/h Paper Feed Speed, $\pm 45^\circ$ Rudder Angle Range	4-02
4.3.3 600 mm/h Paper Feed Speed, $\pm 45^\circ$ Rudder Angle Range	4-03
4.3.4 Zoom Function	4-04
4.3.5 Scale Shift	4-05
4.3.6 The Status Line	4-06
Dimension Drawings	
Interface Specifications	



1. DESCRIPTION

This manual contains all the necessary information for the operation of the adaptive autopilot **NAVIPILOT AD II** manufactured by C. PLATH in Hamburg, West Germany.

1.1 Task of the Adaptive Autopilot

The task of the adaptive autopilot is to steer a ship safely, fast and economically on a preset course. To achieve this, the autopilot compares continuously the heading from the gyrocompass with the course to steer. Deviations between the heading and the course are used by the autopilot to calculate the rudder angle required to correct these deviations. The corrective rudder angle is then transmitted by the autopilot to the steering engine.

The causes of deviation are:

- a) Weather effect: primarily seaway, which moves the ship periodically back and forth, i.e. causes the ship to swing about the set course.

- b) Ship effect: The natural behaviour of the ship, which is caused by asymmetrical cargo and trim, and leads to a one-sided course deviation, which usually increases with time.
A further cause may be instability, which turns the ship in the "wrong" direction when small movements of the rudder are made.

NAVIPILOT AD II can distinguish between course deviations caused by the ship effect and periodic course deviations caused by weather conditions, and can therefore avoid unnecessary course corrections and rudder movement.



This is more economical because each movement of the rudder slows down the ship,

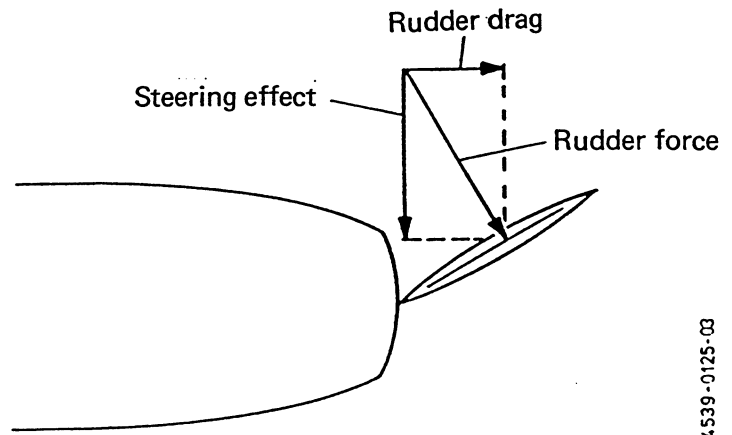

4539-0125-03

because hull drag increases when the ship makes a turn

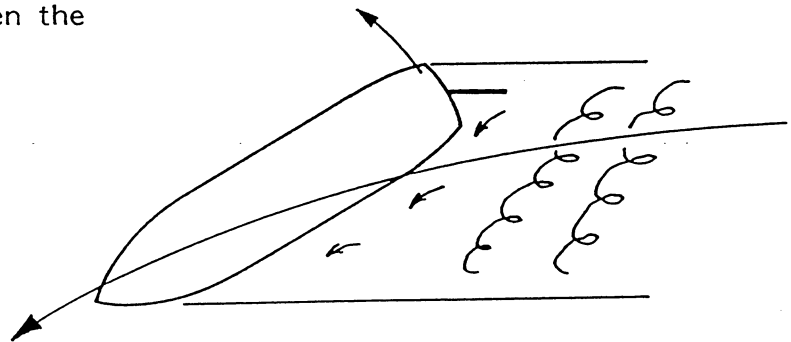

and because the shortest distance through a seaway is not a straight line (as the course to steer is).

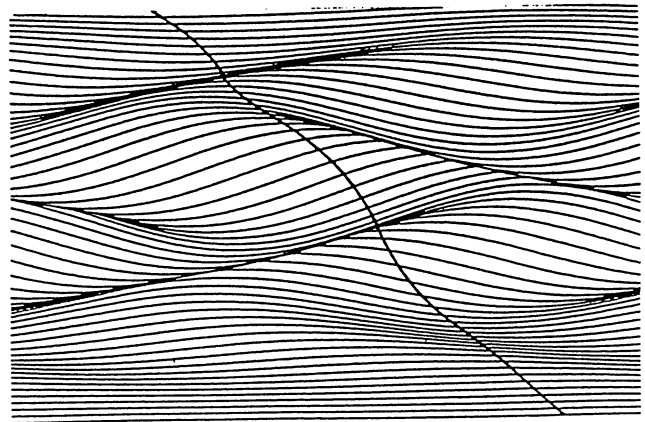

With **NAVIPILOT AD II** the ship's officer has the choice between straight course keeping (which compensates for the weather effect) and relaxed economic steering, which allows the ship to deviate about the course to steer.

The operator is freed from the task of setting controls such as rudder, counter rudder, yaw, etc. Because **NAVIPILOT AD II** precalculates the steering behaviour of the ship, it is capable of determining in advance the optimum rudder and counter rudder values when course corrections and course changes are made.



1.2 Function

The basis on which NAVIPILOT AD II functions is the optimum adaption of its control behaviour to the dynamic characteristics of the ship with, however, only manual input of sea and weather conditions as assessed by the operator. That is to say, the adaptive autopilot, after the operator has selected a steering strategy suitable to the prevailing sea and weather conditions (confined waters, open sea, rough seas), will adapt itself to an optimum to the behaviour of the ship.

Mathematical processes exist in control technology with the aid of which, when the system to be controlled (ship) is known, an optimum controller can be designed. Accordingly, the adaptive autopilot has three main tasks.

- a) To collect information on the dynamic behaviour of the ship (reaction of the ship to rudder moments and disturbance moments) and from this, determine the parameters.
- b) On the basis of the ships parameters and with consideration to an optimizing criterium selected from three possibles by the operator, calculate the coefficient factors of the controller (design of the controller).
- c) With the controller designed in this way, steer the ship on the preset course, and bring the ship onto a new course in the most efficient way.



1.5 Technical Data

Autopilot System

Ambient temperature range	operation	-10°C to +70°C
	storage	-25°C to +70°C
Protection grade	installed	IP 56 to DIN 40050
	not installed	IP 43 to DIN 40050
Minimum magnetic clearance (installed) to standard magnetic compasses		≤ 1 m
steering magnetic compasses		≤ 0.5 m
Vibration	fulfills curve 1 of the specifications of Germanischer Lloyd	
Humidity	fulfills the specifications of Germanischer Lloyd	
Electromagnetic compatability minimum clearance of antennas and their power supply lines for marine radio areas between 1.6 MHz and 30 MHz at a transmission power of 1.5 kW		≥ 1.5 m
The clearance to VHF antennas, their power supply lines and radar appliances is not restricted.		
Radio interference classification	K	
in accordance with VDE 0871 Radio Iterference Suppression of Radio Frequency Equipment for Industrial Purposes and VDE 0875 Radio Interference of Electrical Appliances and Systems		
Front plate dimensions	288 mm x 96 mm to DIN standard	
Depth	35 mm approx.	
Weight	1 kg approx.	
Front plate	sealed keyboard, illuminated	
Display	liquid crystal, illuminated	



Cable connection Power input	D-type plug connectors 24 VDC (18 V to 36 V)
Max. ripple content	4 V pp, extreme values should not exceed 40 V or fall below 19 V
Power consumption	10 W max.
Reverse polarity protection	built-in
Cable connections	D-type plug connectors
Potentiometer in rudder angle feedback unit Total resistance	± 10 V $\pm 45^\circ$ rudder angle 2 K Ohm
Potentiometer in follow-up handwheel	± 10 V $\pm 45^\circ$ rudder angle
Fluxgate coil for magnetic compass	sine/cosine, supplied by C. PLATH
Electronic compass	through NMEA 0183 interface
NMEA 0183 interface	waypoint steering (sentence selectable) from GPS, Satnav, Loran C and others
Status signals	auto, manual, nav, master, repeater
Gyrocompass input	standard is RS 422 from a C.PLATH gyrocompass
Option	6 steps / 1 degree or synchro 1:360



OUTPUTS

Outputs to Steering Engines

DC Output

Switching transistors

two for port

two for starboard

switched plus or minus

18 V DC to 110 V DC

2.0 A max.

Type

Voltage

Rating

or

AC Output

Solid-state AC relays

two for port

two for starboard

110 V AC to 240 V AC

1 A max.

Voltage

Rating

and

Output to proportional
steering engine valve (option)

max. three

220 mV DC/° rudder

angle (isolated

output)

Output Alarms and Interfaces

Serial output interface

RS 422

for connection to

autopilot repeaters

External course alarm

Maximum current

Maximum voltage

Potential-free contact

2.0 A

250 V

180° turn command

port and starboard

Power failure alarm

visible and audible

and

potential-free contact

max. current 2 A

max. voltage 250 V

Magnetic compass heading

or

Electronic compass heading

3 outputs each

6 steps/degree, 0.25°



2. OPERATION

2.1 Foreword

The NAVIPILOT AD II Autopilot System has been developed and manufactured with the aid of the most modern technology and therefore incorporates many functions and features which were not available in previous autopilots. Consequently, the terminology associated with autopilot systems has been changed and expanded to cover the demands of state-of-the-art technology. The major terminology modifications are:

Actual Heading (previously Heading)
Set Heading (previously Course)
Set Course

Actual Heading is the horizontal direction in which a vessel points at any time and in relation to geographic north or magnetic north.

Set Heading is the angle between geographic or magnetic north and the direction in which a vessel is to be steered by the autopilot.

Set Course is the angle between geographic or magnetic north and the direction over ground in which a vessel is to be steered by the autopilot from way point to way point in combination with, for example a GPS receiver.

2.2 General

In restricted waterways manual steering is recommended, and particularly so in conditions of poor visibility. Switching from manual steering to autopilot steering is possible at all times, regardless of whether the autopilot is to hold the existing set heading or carry out a change in the set heading.

NOTE: In the manual steering mode, the Set Heading display will always indicate the same value as the Actual Heading display so as to rule out unwanted or erroneous changes in the vessel's heading when the steering mode is switched to Autopilot.



2.3 Controls

After the Setup and Adaption Procedures (see section 3) have been completed, the autopilot will be ready to steer a ship accurately and efficiently to preset heading without the aid of a helmsman. In order to carry out this task, the autopilot provides the operator with the following controls.

AUTO

Press to switch from NAVigation interface steering mode (e.g. way point navigation with GPS) back to the AUTOpilots steering mode.

NAV

Press to receive the set heading for the autopilot in the NAVigation interface mode from a GPS receiver or an Integrated Navigation System, for example.

ENTER

Press to store the following steering parameters:

RUDDER LIMIT range: 5°, 10°, 15°, 20°, 25°
see Setup Procedure for maximum rudder angle.

STEERING STRATEGY

	{	Σ	LOCK
confined waters	open sea	rough sea	to use fixed parameters

RATE °/min range: 0.1°/min. to 199°/min.
RADIUS nm range: 0.1 nm to 199 nm

SPEED kt manual range: 5.0 knots to 99 knots
automatic input through NMEA 0183 or 200 pulse/nm
NOTE: Speed input format can only be altered in the SETUP procedure.

OFF COURSE ALARM range: 5°, 10°, 15°, 20°, 25°, 30°, 35°

MAGNETIC VARIATION range: 99.9° west to 99.9° east

ALARM RESET switches off the audible alarm

DIM -

decreases illumination intensity

DIM +

increases illumination intensity

NOTE: See Setup Procedure for basic illumination settings.



DIM
-

DIM
+

when pressed simultaneously, initiate self-test function.

AUTO

ENTER

when pressed simultaneously, initiate the adaption procedure

RUDDER
LIMIT
OFF

when pressed, switches the rudder limit off.

- CONTROL DISK
- a) turn clockwise (cw) or counterclockwise (ccw) to set parameters and change the set heading.
 - b) override function in NAVigation interface steering mode.

AUDIBLE ALARM and a visual alarm are actuated for the following reasons:

- a) when the off course alarm has been exceeded.
- b) gyrocompass/magnetic compass heading difference.
- c) power failure.
- d) gyrocompass failure.
- e) magnetic compass failure.
- f) when the Setup Procedure is actuated in the autopilot steering mode.
- g) when the NAVigation interface mode is selected in the manual steering mode.
- h) when the automatic 200 pulse/nm speed input falls below 3 knots.

2.4 Storing Parameters

2.4.1 General

The autopilot provides the Operator with the following six parameters to enable him to optimize the performance of the autopilot to suit the prevailing wind, sea and draught conditions.

RUDDER LIMIT range: 5°, 10°, 15°, 20°, 25°

NOTE: See Setup Procedure for maximum rudder angle.

STEERING
STRATEGY

	}	~	Kool
confined waters	open sea	rough sea	to use fixed parameters



RATE °/min range: 0.1°/min. to 199°/min.
RADIUS nm range: 0.1 nm to 199 nm

SPEED kt manual range: 5.0 knots to 99 knots
automatic input through NMEA 0183
or 200 pulse/nm

NOTE: Speed input format can only be
altered in the SETUP procedure.

OFF COURSE ALARM range: 5°, 10°, 15°, 20°, 25°, 30°, 35°

MAGNETIC VARIATION range: 99.9° west to 99.9° east

Before the parameters are stored for the vessel concerned, it is recommended that the information contained on the following pages with regard to the various parameters be studied.

2.4.2 Steering Parameter Selection Procedure

The above mentioned parameters may be changed in the autopilot steering mode as well as in the manual steering modes.

NOTE: Press to exit the parameter storing procedure at any time.

1. Press to initiate the storing procedure.

The RUDDER LIMIT value will flash to request an input.

NOTE: Parameter values will flash for 10 seconds. If the parameter is not changed in this period, it will cease to flash and the storing procedure will have to be initiated again by pressing

2. Turn the control disk cw or ccw to bring the RUDDER LIMIT to the required value.

NOTE: See the Setup Procedure and the SETUP TABLE for maximum rudder limit.

3. Press to store the RUDDER LIMIT. The

STEERING STRATEGY display will flash to request an input.



4. Turn the control disk slowly cw or ccw to bring the STEERING STRATEGY display to the required symbol (with or without the LOCK function, see 2.5.2.
5. Press to store the selected steering strategy. An arrow indicating either RATE °/min or RADIUS nm will flash to request an input.
6. Turn the control disk cw or ccw to select either RATE °/min or RADIUS nm.
7. Press to store either RATE °/min or RADIUS nm. The number value in the RATE/RADIUS display will flash to request an input.
8. Turn the control disk cw or ccw to bring the RATE/RADIUS display to the required value.
9. Press to store the RATE/RADIUS value.
10. The SPEED kt display will flash to request an input only when the speed display is switched to the manual mode, which is indicated by an M in the top lefthand corner of the SPEED display. If the speed input is automatic, an A will appear in bottom lefthand corner of the SPEED display and an input will not be necessary, simply press to continue the parameter storing procedure.
NOTE: The speed input format is selected in the SETUP procedure.
11. In the manual SPEED display mode, turn the control disk cw or ccw to select the required speed value.
12. Press to store the manual speed input.
The OFF COURSE ALARM value will flash to request an input.
13. Turn the control disk cw or ccw to bring the OFF COURSE ALARM to the required value.
13. Press to store the OFF COURSE ALARM value.
The MAGNETIC VARIATION value will flash to request an input.
The correction range is from 99.9° west to 99.9° east.
11. Turn the control disk cw or ccw to bring the MAGNETIC VARIATION display to the required value.



12. Press to store the MAGNETIC VARIATION value.

The MAGNETIC VARIATION display will cease to flash to indicate that the parameter storing procedure has been completed.

NOTE: Single parameters may be changed by pressing

repeatedly to "jump" to the required parameter, which may be changed by turning the control disk as described above. To exit to the normal operation

mode after changing a single parameter, press

2.5 The Effects and Uses of the Steering Parameters

2.5.1 Rudder Limit and Rudder Limit Off

The RUDDER LIMIT selected during the parameter storing procedure remains active until the key

is pressed to deactivate this rudder limit, whereby the RUDDER LIMIT display defaults to the maximum rudder limit selected in the Setup Procedure (see Setup Procedure and the SETUP TABLE).

To return to the original RUDDER LIMIT value, press

. The RUDDER LIMIT display will flash to request an input.

Turn the control disk cw or ccw to bring the display to the RUDDER LIMIT required. RUDDER LIMIT range is 5°, 10°, 15°, 20°, 25°.

Press to store the RUDDER LIMIT value and to exit to the normal autopilot operation mode.

NOTE: A flashing arrow will appear on the lefthand side of the RUDDER LIMIT display when the maximum rudder angle has been reached.

2.5.2 Steering Strategy

The adaptive autopilot NAVIPILOT AD II is able to recognize the dynamic characteristics of a ship, but unfortunately it is not able to decide which steering strategy is to be used with regard to sea space conditions and the prevailing state of the sea. Therefore, this decision is placed in the hands of the operator.



The operator has the choice of three different types of steering strategy:

a) Confined waters

In confined waters (e.g. an estuary) it will be necessary to hold the ship exactly on course. In heavy seas, increased rudder activity and an enlarged resistance to propulsion will have to be accepted.

Confined water steering strategy is selected by storing the confined waters symbol \square in the steering parameter selection procedure.

b) Open Sea

In open sea with a moderate seaway, average accurate course keeping is required where rudder movement should be seldom and then only with small rudder angles. This results in low wear and tear and economic steering because the resistance to propulsion is not unduly increased.

Open Sea steering strategy is selected by storing the open sea symbol $\{$ in the steering parameter selection procedure, see 2.4.2.

c) Rough Sea

In medium-heavy to heavy seas as well as in open seas, it is possible that it can be very uneconomical to hold the ship on course against the almost periodical back-and-forth movement of water masses. In such cases, a steering strategy should be chosen which will spare the steering engine and hold the ship on course over a time average and in other respects permits a straight course relative to the moving water. Smaller rudder angles and consequently reduced resistance to propulsion result in lower fuel costs and steering engine wear.

Rough Sea steering strategy is selected by storing the rough sea symbol \sim in the steering parameter selection procedure, see 2.4.2.

d) Lock

In rare circumstances (in extremely heavy seas) the ship's parameters may become unstable, which will be noticeable by the behaviour of the ship.

In such cases, the LOCK function may be used to:

a) "Lock-on" to the ship's parameters stored in the SETUP procedure, i.e. the adaption procedure to the ship's characteristics is interrupted

and

b) to control the ship only according to the type of steering strategy currently selected, i.e. confined waters, open sea, rough sea.



When the cause of the instability has disappeared, return to a suitable steering strategy without the lock function.

See 2.4.2 for selection of steering strategy.

2.5.3 Rate and Radius

Two means are provided for bringing the ship on to a new course:

- a) angular rate steering control in degrees per minute. Range is from 0.1 °/min. to 199 °/min.
- b) radius steering control in nautical miles. Range is from 0.1 nm to 199 nm.

It is up to the officer in command to select which type of steering control is best suited to the current navigation situation and the ship's characteristics. An arrow will appear on the lefthand side of the rate or radius display when the maximum preset rate or radius value has been attained.

See 2.4.2 for selection of Rate and Radius control.

2.5.4 Speed Input

Navipilot AD II provides the operator with three different speed input formats. These are:

- a) Manual
- b) Auto 200 pulses per nautical mile
- c) Auto through interface NMEA 0183

The speed input format can only be selected in the SETUP procedure, see 3.5.

2.5.5 Off Course Alarm

In the off course alarm function the autopilot compares the heading references ACT HDG and SET HDG with the current threshold of the off course alarm function and activates audible and visual alarms when this threshold is exceeded. The off course alarm range is: 5°, 10°, 15°, 20°, 25°, 30°, and 35°.

When the autopilot receives both gyrocompass and magnetic compass headings, it will automatically compare these headings with each other and when a deviation in excess of the the current off course alarm threshold is detected, it will actuate audible and visual alarms.

The actuation of an external off course alarm (in a remote alarm panel, for example) may be delayed by a preset delay function. The time delay range is 0 through 300 seconds in increments of 10 seconds.

To program the time delay for the off course alarm, see step 17 in *3.5 Setup Procedure*.



2.5.6 Magnetic Variation

The magnetic compass display can be corrected for magnetic variation (also called magnetic declination). Magnetic variation is the angular deviation of a magnetic compass, uninfluenced by local causes, from the true north and south. The variation differs at different points on the earth's surface and at different times of the year. The applicable magnetic variation correction value can be taken from the sea chart relevant to the area in question.

Proceed as follows to store the magnetic variation correction value.

1. Press **ENTER** six times. The MAGNETIC VARIATION display will flash.
2. Turn the control disk cw or ccw to bring the display to the required display value. The correction range is from 99.9° west to 99.9° east.
3. Press **ENTER** to store the correction value and return to the normal autopilot operation mode.

2.6 Preset Heading

In autopilot operation (and in a manual steering mode) a new set heading may be preset and taken over exactly at the point in time when it is required.

Procedure

1. Press **AUTO** and the display *PRE-SET HDG* will flash to request an input.
2. Using the control disk, set the preset heading to the next required set heading.
3. As soon as the preset heading is required, switch to autopilot control if manual steering is selected, and press **AUTO** to take over immediately the preset heading as the new set heading.



2.7 Switchover to Autopilot Control

1. Ensure that the set heading (course to steer) is correctly set on the autopilot.
2. If the steering engine has two different speeds, select the slower speed.
3. Turn the steering mode selector switch to the "AUTO" position.
4. Observe the operation of the autopilot by noting how the vessel takes up the set heading. For this purpose, the autopilot is provided with an analogue display of the difference between the actual heading and the set heading see the Setup Procedure on page 3-02).

2.8 Synchronization of the Autopilot ACTual HeaDinG Display with the Heading of the Gyrocompass (serial interface only, C.PLATH or NMEA format)

1. Select a manual steering mode.
2. Read the warning label on the gyrocompass Electronic Power and Control Unit (EPCU).
3. Press the green synchronization switch on the EPCU. The heading display on the autopilot will flash and gyrocompass compass card system will turn to bring the north symbol to the lubber line (maximum duration 40 sec.) where it will remain.
4. Press again the green synchronization switch on the EPCU. The compass cards will return to the current heading. The flashing heading display on the autopilot will also show the current heading from the gyrocompass. When the heading display on the autopilot ceases to flash, synchronization is complete.

2.9 Synchronization of the Autopilot ACTual HeaDinG Display with the Heading of the Gyrocompass (6 steps and synchro outputs only)

To synchronize the autopilot ACTual HeaDinG display with the gyrocompass and/or magnetic compass, proceed as follows.

1. Select a manual steering mode.
2. Press simultaneously the keys **ENTER DIM**
+
3. The ACTual HeaDinG display will flash.
4. Turn the control disk cw or ccw to bring the ACTual HeaDinG display to the heading displayed by the compass in question.
5. Press **ENTER** to takeover the the new ACTual HeaDinG. Synchronization is complete and the display will cease to flash.

2.10 Override Function

When the autopilot is operated in the NAVigation interface mode, the control disk provides the operator with an override function. When the control disk is turned, the autopilot switches immediately to the **AUTO** steering mode to enable the operator to carry out an immediate change to the set heading.

Press **NAV** to return to the NAVigation interface steering mode.



- 2.11 Display of the Current Software Revision Number
1. Select a manual steering mode.
 2. Press simultaneously the keys **ENTER RESET DIM**
1/10° -
to enter the setup procedure.
 3. Press **AUTO** to exit the setup procedure. The current software revision number will be shown in the display for approximately two seconds.



C. PLATH
NAVIGATION · AUTOMATION

INTENTIONALLY LEFT BLANK



3 INSTALLATION AND INITIALIZATION

3.1 General

Before the autopilot can be used to steer a ship, a number of basic parameter settings have to be carried out which depend on the size of the ship in question, the requirements of the operator and the configuration of the peripheral equipment. Entering and storing these basic parameter settings is called the **Setup Procedure**, see 3.5.

3.2 Before Installation

Before installation of the autopilot, the dip switches in block K1 on the computer PCB have to be set according to whether the function of the autopilot is intended to be that of a **Master** or **Repeater** Unit. Normally, these dip switches are set by the manufacturer according to the customer's order. However, before installation, the position of these switches should be checked.

MASTER:	K1	REPEATER:	K2
	1 off		1 off
	2 off		2 off
	3 off		3 off
	4 off		4 off
	5 off		5 off
	6 on		6 on
	7 on		7 on
	8 on		8 off

Dip Switch Block K1 on Computer PCB

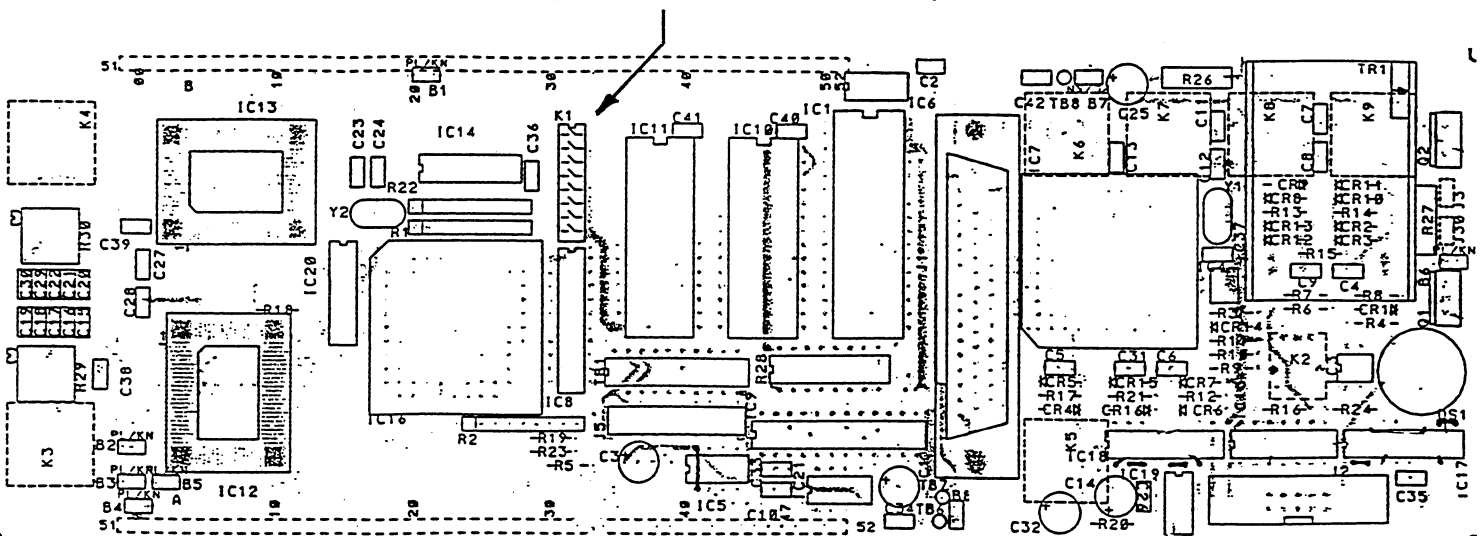

Figure 3-01 Computer PCB



3.3 Installation

1. Install the components of the autopilot system in accordance with the drawings, diagrams and documents provided by the manufacturer.
2. Carry out all wiring work in accordance with the manufacturer's interconnection diagram. Do not yet energize the system.

3.4 After Installation

1. Bring the steering mode selector switch into the MANUAL position.
2. Energize the autopilot system. The autopilot will perform a self-test. After the self-test has been completed (approximately 5 sec.) the autopilot will display the heading of the compass currently selected as the heading reference (gyrocompass or magnetic compass) for the autopilot. To indicate the manual steering mode, the autopilot will show **MAN** on the left-hand side of the display, see Fig. 3-02. The Setup Procedure for the basic operational parameter settings may now be carried out, see 3.5.

NOTE: If an interface alarm is displayed, press **ALARM** to switch off the **RESET** audible alarm and continue with the Setup Procedure.

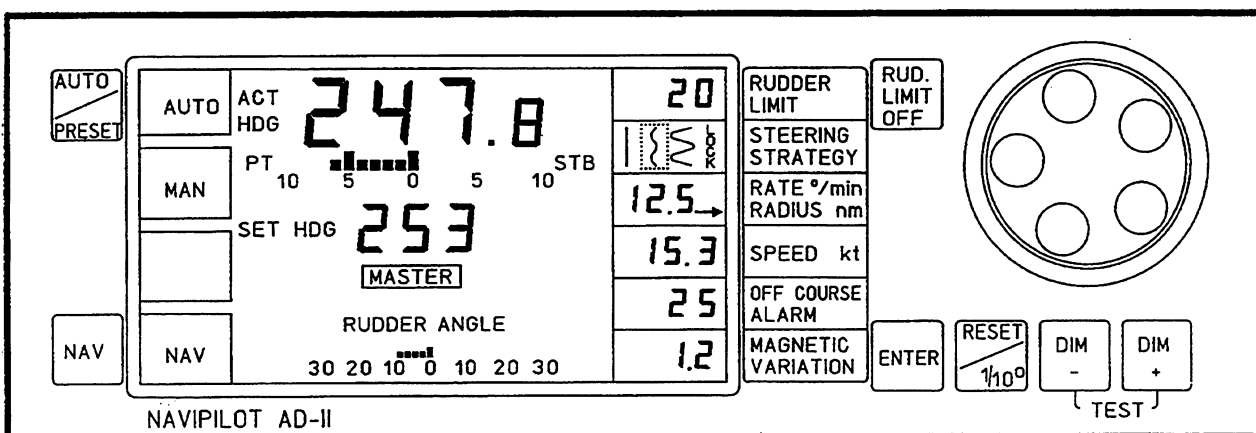

Figure 3-02 Normal Operational Display



3.5 Setup Procedure

NOTE: During the Setup Procedure, magnetic compass repeaters will remain stationary.

1. Initiate the setup procedure by pressing simultaneously the keys
ENTER RESET DIM
1/10° -

The display will change to **t A U**
10

The tau value (in this case 10) will flash. This is a request for the input of the ship's time constant factor (tau). The time constant factor can be determined with the aid of the NOMOGRAM on page 3-32.

NOTE: To exit the Setup Procedure before completion press **AUTO**

2. Using the NOMOGRAM, determine the time constant factor (tau) for the ship in question, see section 3.7.
3. For future reference, enter the time constant factor (tau) in line 1 of the SETUP TABLE in section 3.6.
4. Turn the control disk (normally used to select the set heading i.e. course to steer) cw or ccw to bring the display to the required tau value.
5. Press **ENTER** to store the time constant factor.

The display will change to **U o** (cruising speed) and a cruising speed will be displayed. The cruising speed will flash to request the input of the vessel's normal cruising speed. The cruising speed range is from 5 knots to 99 knots.

6. Enter the cruising speed in line 2 of the SETUP TABLE in section 3.6.
7. Turn the control disk cw or ccw to bring the display to the required cruising speed.
8. Press **ENTER** to store the vessel's cruising speed value. The display will change to one of the following NMEA sentence formats.

No. 0	OFF	NMEA	interface switched off.
No. 1	HSC	HSC	steering heading command.
No. 2	b o d	BOD	bearing to destination waypoint from origin waypoint.



No. 3	APA	APA	autopilot format A.
No. 4	APb	APB	autopilot format B.
No. 5	CtS	CTS	course to steer.
No. 6	PCT	PCTS	precision course to steer.
No. 7	bPI	BPI	bearing to point of interest.
No. 8	bur	BWR	bearing to selected waypoint rhumbline.
No. 9	buc	BWC	bearing to selected waypoint great circle.
No. 10	INS 1	INS 1	integrated navigation system 1 (C.PLATH general).
No. 11	INS 2	INS 2	integrated navigation system 2 (C.PLATH chart plotters NAVILOT I & II).
No. 12	INS 3	INS 3	integrated navigation system 3 (C.PLATH special).
No. 13	INS 4	INS 4	integrated navigation system 4 (C.PLATH special).
No. 14	INS 5	INS 5	integrated navigation system 5 (C.PLATH special).

The display will flash to request the input of the NMEA sentence format, see section 5 for interface specifications.

The autopilot provides the operator with 13 different NMEA sentence formats for interfacing the autopilot to GPS receivers, Loran, integrated navigation system, etc.

NOTE: If the autopilot is to be operated in the **NAV** steering mode, i.e. in which the set heading information for the autopilot is provided by a GPS receiver, Loran, integrated navigation systems, etc., turn the control disk through approximately a further 360° after selecting the NMEA sentence format so that **NAV** appears flashing in the lower



left-hand corner of the display. This indicates that when in the **NAV** mode, the autopilot will sound an alarm when it receives a new set heading. Takeover of the new set heading is carried out by pressing the **NAV** key.

NOTE: If an NMEA sentence format is not required, select **OFF**.

9. Enter the required NMEA sentence format in line 3 of the SETUP TABLE in section 3.6.
10. Turn the control disk cw or ccw to bring the display to the required NMEA sentence format, with or without the **NAV** function.
11. Press **ENTER** to store the NMEA sentence format.

NOTE: If one of the following sentence formats is stored BOD, APA, APB, BPI, BW, BUC, INS 1 through INS 5, the display will change to

SEns (sensitivity)

0

If this is not the case, proceed at step 12.

- a) A number will flash to request an input of the NMEA sensitivity.

NOTE: NMEA sensitivity controls the rate at which cross track error (XTE) is corrected - faster for small vessels, slower for large vessels. The sensitivity values produce an asymptotic approach to the track. If the operator considers that the approach is too slow, he should select a higher sensitivity value corresponding to a shorter ship's length.

NOTE: The set heading offset is limited to 75°. The sensitivity values from 10 to 20 are only to be used in combination with highly accurate navigation receivers such as differential GPS.

The following table provides sensitivity values and set heading offset information.

NMEA Sensitivity	Set Heading Offset [°] at XTE = 0.01 nm	NMEA Sensitivity	Set Heading Offset [°] at XTE = 0.01 nm
20	75	9	1.5
19	75	8	1.0
18	50	7	0.75
17	30	6	0.5
16	20	5	0.30
15	15	4	0.20
14	10	3	0.15
13	7.5	2	0.10
12	5.0	1	0.08
11	3.0	0	0.05
10	2.0		



- b) Enter the required NMEA sensitivity value in line 4 of the SETUP TABLE in section 3.6.
- c) Turn the control disk cw or ccw to bring the display to the required NMEA sensitivity value.
- d) Press **ENTER** to store the NMEA sensitivity value.

12. The display will change to ***rud***
35

The number will flash to request the input of the required maximum rudder angle. The maximum rudder angle range is 20°, 25°, 30°, 35°.

- 13. Enter the required maximum rudder angle in line 5 of the SETUP TABLE in section 3.6.
- 14. Turn the control disk cw or ccw to bring the display to the required maximum rudder angle.
- 15. Press **ENTER** to store the required maximum rudder angle.
The display will change to

rud

220 INTERFACE

RUDDER ANGLE
|
30 20 10 0 10 20 30

The number will flash to request the input of the scale factor (mV) of the input signal from the rudder angle potentiometer in the feedback unit.
The scale factor for a maximum rudder angle range of $\pm 45^\circ$ is 220 mV/°.
The scale factor for a maximum rudder angle range of $\pm 70^\circ$ is 141 mV/°.
The scale factor for other rudder angle ranges and for non C.PLATH feedback units will have to be determined accordingly.

- 15a. Enter the rudder angle scale factor in line 6 of the SETUP TABLE in section 3.6.
- 15b. Turn the control disk cw or ccw to bring the scale factor to the required value.
- 15c. Press **ENTER** to store the scale factor.



The display will change to **rAtE** or **rds** and will flash to request the selection of the required steering mode, either RATE or RADIUS.

16. Turn the control disk cw or ccw to select the required steering mode. An arrow in the *RATE/°min* and *RADIUS nm* display window will indicate which steering mode is currently selected.

17. Press **ENTER** to store the selection. The display will change to **0**
O C A

The number will flash to request the input of a time delay for the external **Off Course Alarm**. The time delay range is 0 through 300 in increments of 10 seconds. If the **Off Course Alarm** is switched off within the time delay period, the external alarm will not be actuated.

18. Enter the external off course alarm time delay in line 6 of the SETUP TABLE in section 3.6
19. Turn the control disk cw or ccw to bring the external off course alarm time delay to the required value.
20. Press **ENTER** to store the off course alarm time delay.
The display will change to **I . 0 M**

CONTINUED ON PAGE 3-07.



C. PLATH
NAVIGATION · AUTOMATION

INTENTIONALLY LEFT BLANK



I . o M will flash to request the input of the format for the magnetic compass display, i.e. with or without tenths of a degree: I . oM or I M.

21. Enter the format of the magnetic compass display in line 7 in the SETUP TABLE in section 3.6.
22. Turn the control disk cw or ccw to bring the magnetic compass display to the required format .
23. Press **ENTER** to store the required format for the magnetic compass display. The display will change to ^{ACT}_{HDG} **OFF M**

OFF will flash to request the selection of the input signal format from the magnetic compass. The formats available are

OFF for no magnetic compass input signal.

S/n sine or cosine input.
cos

0183 for input through the NMEA 0183 interface.

24. Enter the magnetic compass input signal format in line 8 in the SETUP TABLE in section 3.6.
25. Turn the control disk cw or ccw to bring the display to the required magnetic compass input signal format.
26. Press **ENTER** to store the magnetic compass input signal format.

The display will change to ^{ACT}_{HDG} **6 Yr O**
P 9 6

The number will flash to request the selection of the input signal format from the gyrocompass. The formats available are

OFF for no gyrocompass input signal.

6 for input format 6 steps per degree of azimuth (step motor).

12 for input format 12 steps per degree of azimuth (synchro 1: 360).



- P 9 6** serial input format through RS422 in C.PLATH format 9600 baud.
- L 9 6** serial input format through RS422 in Lehmkuhl (Scandinavian Micro Systems) 9600 baud.
- L 1 2** for Lehmkuhl input format 12 steps per degree of azimuth.
- 1 8 3** NMEA for input through the NMEA 0183 heading interface.
- n t** NMEA for input from the compass monitor NAVITWIN II .

NOTE: If, after selection of the RS422 serial input format, the alarm INTERFACE FAILURE HDG is given and the ACT HDG value flashes after the setup procedure has been completed, it may be necessary to synchronize the serial heading interface output of the gyrocompass, see 2.8.

27. Enter the gyrocompass input format in line 9 of the SETUP TABLE in section 3.6.
28. Turn the control disk cw ccw to bring the display to the required gyrocompass input signal.
29. Press **ENTER** to store the gyrocompass input signal format.

The display will change to

An
RUDDER ANGLE
|
30 20 10 0 10 20 30

An = for analogue steering engines.
Indicates the set rudder angle on an analogue display (when a rudder angle signal is not available from the feedback unit).

or

bb
RUDDER ANGLE
|
30 20 10 0 10 20 30

bb = for bang bang steering engines.
Indicates the current rudder angle on an analogue display from the rudder stock.

NOTE: If a voyage data recorder is used with an analogue steering system to record the actual rudder angle direct from a feedback unit, select **bb** (for bang bang) otherwise the rudder angle will not be recorded.

The display will flash to request the selection of the format of the rudder angle display.



30. Enter the required rudder angle display format in line 10 of the SETUP TABLE in section 3.6.
31. Press **ENTER** to store the rudder angle display format. The display will change to

AUTO **OFF**
SPd

This is a request for the format of the automatic speed input. The following speed input formats are provided

OFF for no automatic speed input. Instead, manual input through the operating unit.

200pM for an automatic speed input of 200 pulses per nautical mile.

0183
NMEA for automatic speed input through interface NMEA 0183.

32. Enter the required speed input format in line 11 of the SETUP TABLE in section 3.6.
33. Press **ENTER** to store the speed input selection. The display will change to

CAL M correction of magnetic compass heading **OFF**.
OFF

or

CAL M correction of magnetic compass heading **ON**.
on

The display will flash to request whether or not the magnetic compass heading is to be corrected.

NOTE: If the autoüpilot is used in combination with the compass monitor NAVITWIN II, select OFF and use the correction table in NAVITWIN II.

34. Enter the magnetic compass display format - corrected or not corrected - in line 12 of the SETUP TABLE in section 3.6.
35. Turn the control disk cw or ccw to bring the display to the required magnetic compass display format.



36. Press **ENTER** to store the magnetic compass display format.

NOTE: If the corrected (ON) magnetic compass display format is stored, the display will change to

0.0 M
000
0

MAGNETIC VARIATION

If the corrected display is not stored, proceed at step 36. i).

This is a request for the input of a correction table for the magnetic compass display. A correction table is necessary because the function of a fluxgate pickoff, mounted below the compass, is not exactly linear, which leads to minor deviations between the actual magnetic compass heading and the magnetic compass heading displayed on the autopilot.

Compare at regular intervals (e.g. every 10 degrees) the actual magnetic compass heading with the magnetic compass display on the autopilot. Make a note of any deviations and at which headings and store these in the correction table as follows:

- a) Press **DIM** or **DIM** to bring the magnetic compass heading display
- +
to the heading to which a correction value is to be applied e.g. 359°

-.-. M
359
0

MAGNETIC VARIATION

- b) Turn the control disk cw or ccw (cw for plus values, ccw for minus values) to bring the correction value display to the required correction value, e.g. minus 1.5 degrees:

- 1.5 M
359
0

MAGNETIC VARIATION

NOTE: The correction value range is from -20° to +20°.

- c) Press **RUD.** to store the correction value.
LIMIT
OFF



- 1.5 M
359

1 MAGNETIC
VARIATION

NOTE: A reference number will be allotted to each correction value and the associated heading. The reference number (in this case 1) is displayed in the lower right-hand corner of the display next to the legend **MAGNETIC VARIATION**.

Correction values may be deleted by pressing **RESET**
10°

- d) Press **DIM** or **DIM** to proceed to the next magnetic compass heading
- +
to which a correction is to be applied.
- e) Turn the control disk cw or ccw to bring the correction value display to the next correction value applicable to the above heading.
- f) Press **RUD.** to store the correction value.
LIMIT
OFF
- g) Continue as described above until all required magnetic compass headings and their correction values have been stored in the correction table.

NOTE: The headings and their associated correction values can be scrolled by pressing and holding down **DIM** or **DIM**
- +

- h) Enter the magnetic compass headings and their associated correction values in the *Correction Table for the Heading from the Magnetic Compass* in 3.13.
- i) Press **ENTER** to exit the correction table function.

NOTE: Exit the correction table at any time by pressing **ENTER**

The display will change to **PLOt**
on
or **PLOt**
OFF



The display will flash to ask if an output to a plotter/printer is required. The autopilot may be supplied with a voyage data recorder which provides the operator with a graphic record of heading and rudder angle, and other operational data. Select **ON** if a voyage data recorder is to be supported by the autopilot.

See section 4 of this manual for further information on the voyage data recorder.

37. Turn the control disk cw or ccw to bring the display to **ON** or **OFF** as required.
38. Press **ENTER** to store the selection. If **OFF** is selected, proceed at step 56. If **ON** is selected, the display will change to

SPd

60

The number (in this case 60) will flash to request an input of the required paper feed speed. The paper feed speed range is 60mm/h, 150 mm/h and 600 mm/h.

39. Enter the paper feed speed in line 13 of the SETUP TABLE in section 3.6.
40. Turn the control disk cw or ccw to select the required paper feed speed.
41. Press **ENTER** to store the paper feed speed. The display will change to

HdG

30

The number (here 30) will flash to request an input of the range in which the heading of the vessel is to be plotted. The ranges available are $\pm 30^\circ$ and $\pm 180^\circ$ over the same width of paper.

42. Enter the heading range in line 14 of the SETUP TABLE in section 3.6.
43. Turn the control disk cw or ccw to select the required heading range.
44. Press **ENTER** to store the heading range. The display will change to

rud

9

The number will flash to request an input of the rudder angle recording range. The rudder angle recording ranges available are $\pm 9^\circ$, $\pm 45^\circ$ and $\pm 70^\circ$.

45. Enter the required rudder angle recording range in line 15 of the SETUP TABLE in section 3.6.



46. Press **ENTER** to store the rudder angle recording range. The display will change to

Y E A r

9 4

The number will flash to request an input of the required year.

47. Turn the control disk cw or ccw to bring the display to the required year.

48. Press **ENTER** to store the year. The display will change to

n o n

6

The number will flash to request an input of the required month.

49. Turn the control disk cw or ccw to select the required month.

50. Press **ENTER** to store the required month. The display will change to

d A Y

1

The number will flash to request the input of the day's date.

51. Turn the control disk cw or ccw to select the required date.

52. Press **ENTER** to store the date. The display will change to

H r

1 2

The number will flash to request an input of the required time (GMT or local) in hours.

53. Turn the control disk cw or ccw to select the required time in hours.

54. Press **ENTER** to store the time in hours. The display will change to

n i n

2 4

The number will flash to request an input of the time in minutes.



55. Turn the control disk cw or ccw to select the required time in minutes.
NOTE: After a blackout or a power failure of the autopilot, the time and date will have to be reset.
56. Press **ENTER** to store the time in minutes. The display will change to

A d _ d
0 0

The number (here 00) will flash to request a rudder sensitivity input when the autopilot is used in combination with a gyrocompass.

NOTE: Rudder sensitivity is a ship's parameter which is normally determined during the adaption procedure, see 3.8. For initialization purposes, a value of 50 is to be entered when no other information is available, e.g. from a sister ship.

57. Enter the rudder sensitivity in line 16 in the SETUP TABLE in section 3.6.
58. Turn the control disk cw or ccw to set the rudder sensitivity to the required value.
59. Press **ENTER** to store the rudder sensitivity value. The display will change to

A d _ 6
0 0

The number (here 00) will flash to request an input of the gain parameter when the autopilot is used in combination with a gyrocompass. Gain represents the proportional component of the PID controller.

NOTE: Gain is a ship's parameter which is normally determined during the adaption procedure, see 3.8. For initialization purposes, a value of 50 is to be entered when no other information is available, e.g. from a sister ship.

60. Enter the gain value in line 17 in the SETUP TABLE in section 3.6.
61. Turn the control disk cw or ccw to set gain to the required value.
62. Press **ENTER** to store the gain value. The display will change to

A d _ d M
0 0

The number (here 00) will flash to request a rudder sensitivity input when the autopilot is used in combination with a magnetic compass.



NOTE: Rudder sensitivity is a ship's parameter which is normally determined during the adaption procedure, see 3.9. For initialization purposes, a value of 50 is to be entered when no other information is available, e.g. from a sister ship.

63. Enter the rudder sensitivity in line 18 in the SETUP TABLE in section 3.6.
64. Turn the control disk cw or ccw to set the rudder sensitivity to the required value.
65. Press **ENTER** to store the rudder sensitivity value. The display will change to

A d_6 M
00

The number (here 00) will flash to request an input of the gain parameter when the autopilot is used in combination with a magnetic compass. Gain represents the proportional component of the PID controller.

NOTE: Gain is a ship's parameter which is normally determined during the adaption procedure, see 3.9. For initialization purposes, a value of 50 is to be entered when no other information is available, e.g. from a sister ship.

66. Enter the gain value in line 19 in the SETUP TABLE in section 3.6.
67. Turn the control disk cw or ccw to set gain to the required value.
68. Press **ENTER** to store the gain value. The display will change to

L C d L
000

The number will flash to request an input of the minimum illumination intensity of the liquid crystal display. The range of the minimum illumination intensity is from 000 to 049.

69. Turn the control disk cw or ccw to select the minimum illumination intensity.
70. Enter the minimum illumination intensity value in line 20 of the SETUP TABLE in section 3.6.
71. Press **ENTER** to store the minimum illumination intensity value. The display will change to

L C d H
000



The number will flash to request an input of the maximum illumination intensity of the liquid crystal display. The range of the maximum illumination intensity is from 051 to 099.

72. Turn the control disk cw or ccw to select the maximum illumination intensity.
73. Enter the maximum illumination intensity value in line 21 of the SETUP TABLE in section 3.6.
74. Press **ENTER** to store the maximum illumination intensity value.

The Setup Procedure is now complete and the display will return to the normal operational mode. Beforehand, however, the display will show for a short time before returning to the normal operational display the current software revision number. Shown below is an example of a software revision number display:

A - 2 . 3

r n o



3.6 The SETUP TABLE

The information stored during the Setup Procedure is to be entered in this table to provide a future reference for any subsequent changes in the Setup Procedure. Enter values, designations or, accordingly, underline the selection.

Line No.	
1	Time constant factor <i>tAU</i> : sec.
2	Cruising speed: knots
3	NMEA sentence format:
4	NMEA sensitivity value <i>SEns</i> :
5	Maximum rudder angle <i>rud</i> :
6	External off course alarm delay <i>OCA</i> : sec.
6A	Rudder angle scale factor: 220mV/° = ±45° 141mV/° = ±70° other
7	Format of the magnetic compass display: with tenths of a degree <i>1.0 M</i> without tenths of a degree <i>1. M</i>
8	Input signal format from the magnetic compass:
9	Input signal format from the gyrocompass:
10	Set rudder angle: <i>An</i> Current rudder angle: <i>bb</i>
11	Automatic speed input format:
12	Magnetic compass display format: <i>corrected</i> <i>not corrected</i>
13	Paper feed speed: 60 mm/H 150 mm/h 600 mm/h
14	Heading recording range: ±30° ±180°
15	Rudder angle recording range: ±9° ±45°
16	Rudder sensitivity (gyrocompass): <i>Ad_d</i>
17	Gain (gyrocompass): <i>Ad_6</i>
18	Rudder sensitivity (magnetic compass): <i>Ad_dM</i>
19	Gain (magnetic compass): <i>Ad_6M</i>
20	Minimum illumination intensity <i>LCdL</i> :
21	Maximum illumination intensity <i>LCdH</i>



C. PLATH
NAVIGATION · AUTOMATION

THIS PAGE INTENTIONALLY LEFT BLANK



C. PLATH
NAVIGATION · AUTOMATION

THIS PAGE INTENTIONALLY LEFT BLANK



3.7 The Tau Nomogram

NOTE: The tau nomogram may only be used for determining the time constant (τ) for displacement vessels. For other types of ship, the time constant is to be determined empirically.

During the Setup Procedure (see page 3-02) a request is made for the input of the time constant (τ) of the vessel concerned.

The time constant (τ) is determined by entering in the Tau Nomogram on page 3-23 the length of the vessel in meters at the waterline and the average cruising speed. The intersection of these two values results in the time constant (τ) which is to be entered in the SETUP Procedure. An example of how to determine the time constant (τ) for the vessel concerned is shown on the following page.

NOTE: Enter the time constant (τ) in the SETUP TABLE in line 1 on page 3-18 for future reference.

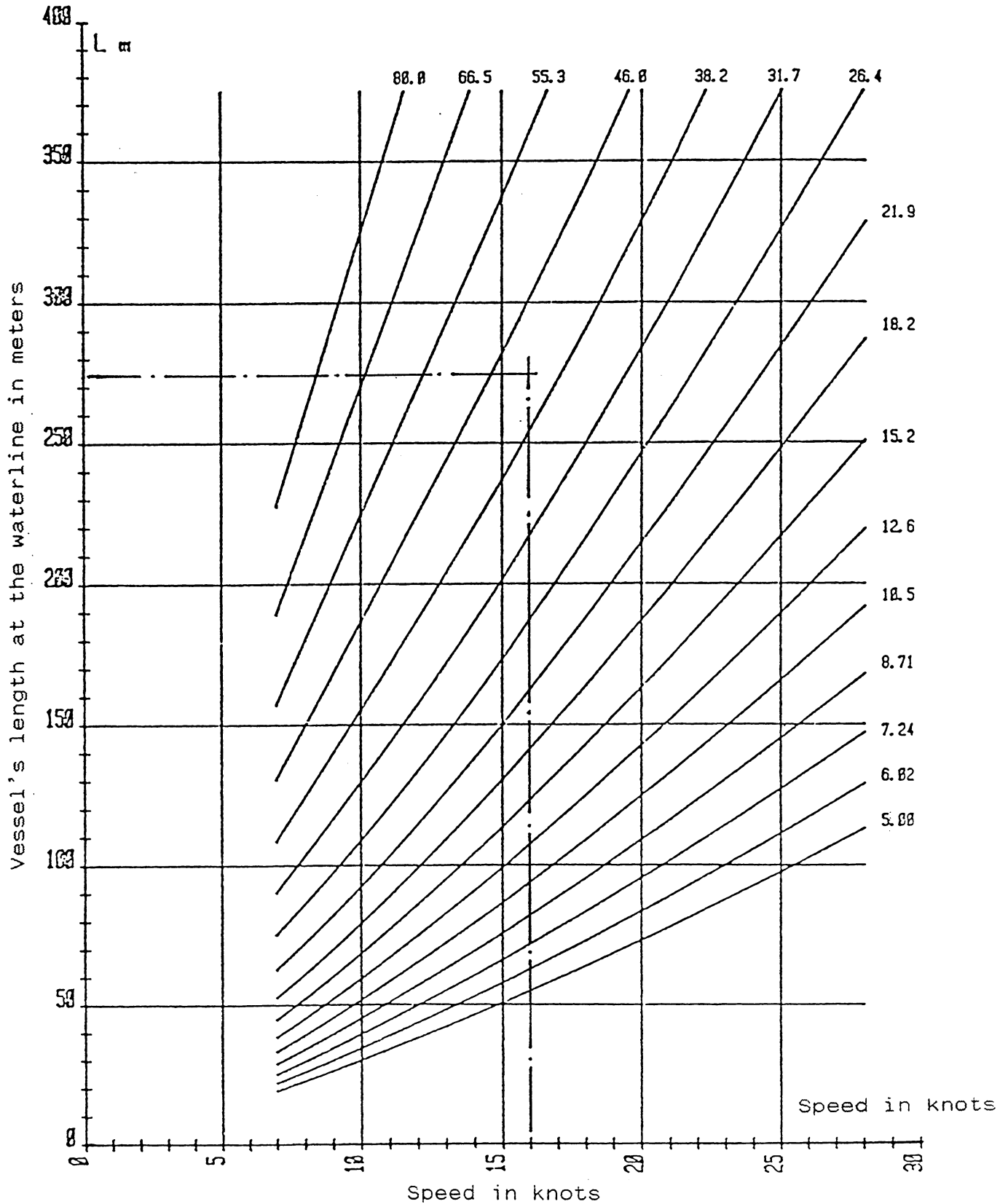

Vessel's length at the waterline in meters: 275 m
Vessel's average cruising speed in knots : 16 kts

The time constant (τ) is 42.1
Round off all values to the nearest whole number, in the above example 42.

Working Example of the Tau Nomogram
Figure 3-02

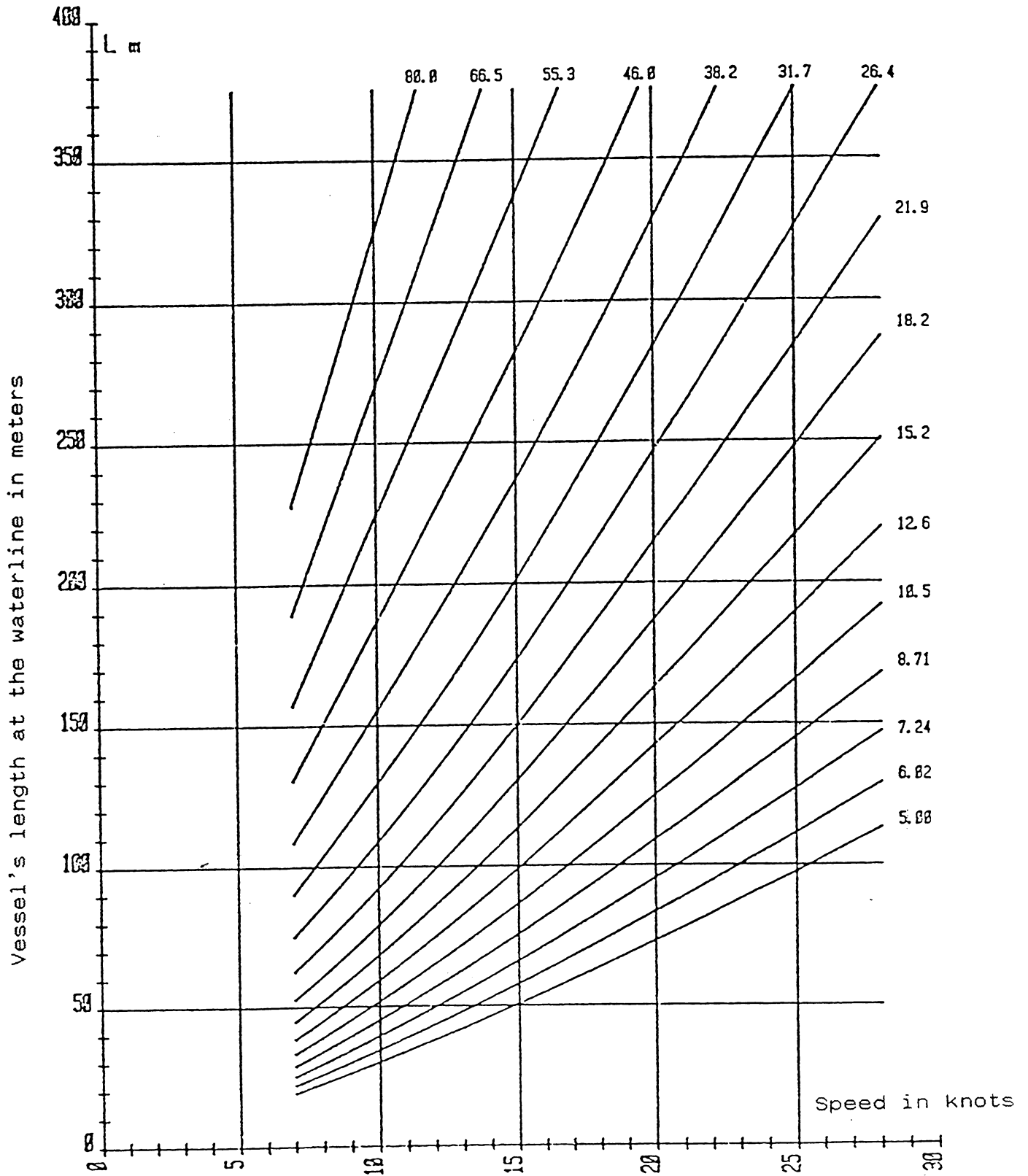

The Tau Nomogram
Figure 3-03



3.8 Adaption Procedure with Gyrocompass Systems

Aquisition of Parameters

Carry out the following procedure to "finely tune" or optimize the adaptive parameters of the ship.

Calm weather during the adaption manoeuvre will provide fast and accurate acquisition of the ship's parameters.

Procedure

1. Select a manual steering mode.
2. Set the rudder limit to not less than 10 degrees.
3. If the ship's speed input is not automatic, enter the normal cruising speed manually.
4. The RATE/°min steering mode is required for the adaption procedure. If the RATE steering mode is not selected, enter the setup procedure (see 3.5) and press **ENTER** repeatedly until the *r d s* (radius) display appears.
5. Turn the control disk to change the display to *r A t e* (rate steering) and press **AUTO** to exit the setup procedure.
6. Press **ENTER** three times. The RATE / RADIUS steering parameter will flash.
7. Turn the control disk clockwise until the highest rate value is displayed e.g.80. For the adaption procedure select 50% of the highest rate value; in this example 40. 50 % of the highest rate value is, however, an approximation and it may be necessary to change it.
8. Press **AUTO** to return to the previous operation mode.
9. Press simultaneously the keys **ENTER** **RESET** **DIM** to enter the setup procedure.

1/10°	-
-------	---
10. Press **ENTER** repeatedly until the *Ad_d* display appears. *Ad_d* is the rudder sensitivity parameter. Turn the control disk to bring the number displayed to 50, or alternatively, enter a value obtained from a sister ship. Press **ENTER** to store this value. The display will change to *Ad_6* (6 = G = g).
11. *Ad_6* is the gain parameter. Turn the control disk to bring the number displayed to 50, or alternatively, enter a value obtained from a sister ship. Press **AUTO** to store this value and exit to the previous operation mode.
12. Press **ENTER** twice. The *Steering Strategy* display will flash. Turn the control disk to select both *Confined Waters* and *Lock*. Press **AUTO** to take over the parameters from the setup procedure.



13. Select now the steering strategy *Confined Waters without Lock*.
14. Select the autopilot steering mode.
15. Press simultaneously **ENTER** and **AUTO** . The following displays will flash and show various adaption procedure related information:
 - **RUDDER LIMIT**
shows the current adaption status, which can be 0, 10, 20, 30, 35, or 38 [0 = no adaption, 10 = good adaption, 20 very good adaption, 30, 35 and 38 = excellent adaption].
 - **RATE / RADIUS**
shows the adaption parameter Ad_d
 - **OFF COURSE ALARM**
shows a time countdown in seconds
 - **MAGNETIC VARIATION**
shows the adaption parameter Ad_g
16. The current adaption status in the RUDDER LIMIT display must be 0 (zero) before the adaption procedure can be started. If the display is not 0, press **ENTER** and hold down, press **RESET** and hold down, press **AUTO** and hold down. Release all three keys simultaneously. The display in RUDDER LIMIT will now be 0 (zero).
17. Using the autopilot, change the set heading by +30°. The time countdown in the OFF COURSE ALARM window will first display 0 (zero). After a short time a number in seconds will appear (e.g. 10 or 35). Hold the +30° heading until the time countdown has reached 0 seconds. When possible, maintain the +30° heading for a further 5 minutes - this will shorten the adaption procedure. Now proceed to step 18.
18. Using the autopilot, change the set heading by -60°. The time countdown in the OFF COURSE ALARM window will first display 0 (zero). After a short time a number in seconds will appear (e.g. 10 or 35). Hold the -60° heading until the time countdown has reached 0 seconds. When possible, maintain the +60 heading for a further 5 minutes - this will shorten the adaption procedure. Now proceed to step 19.
19. Using the autopilot, change the set heading by +60°. The time countdown in the OFF COURSE ALARM window will first display 0 (zero). After a short time a number in seconds will appear (e.g. 10 or 35). Hold the +60° heading until the time countdown has reached 0 seconds. When possible, maintain the +60 heading for a further 5 minutes - this will shorten the adaption procedure. Now proceed to step 20.



20. Using the autopilot, change the set heading by -30° . The time countdown in the OFF COURSE ALARM window will first display 0 (zero). After a short time a number in seconds will appear (e.g. 10 or 35). Hold the -30° heading until the time countdown has reached 0 seconds. When possible, maintain the -30° heading for a further 5 minutes - this will shorten the adaption procedure. then Now proceed to step 21.
21. If the adaption status (in the RUDDER LIMIT window) exceeds 10, proceed to step 22.
If the adaption status is less than 10, carry out more manoeuvres as described in the sequence above.
When the adation status has reached at least 10 (20 would be better) proceed to step 22.
22. Make a note of the adaption values as displayed: Ad_d (RATE/RADIUS), Ad_g (MAGNETIC VARIATION).
23. Press **ENTER** and **AUTO** simultaneously. The display will return to the normal operational mode and display again all the steering parameters.
24. Select a manual steering mode (FU or NFU).
25. Press simultaneously the keys **ENTER**, **RESET** and **DIM** to enter the setup mode.
 $1/10^\circ$ -
26. Press **ENTER** repeatedly until **Ad_d** is displayed. Turn the control disk cw or ccw to enter the value recorded for the Ad_d parameter.
27. Press **ENTER** once to display the **Ad_6** parameter value. Turn the control disk cw or ccw to enter the value recorded for the Ad_g parameter.
28. Press **AUTO** to return to the normal autopilot operation mode; the adaption procedure is now complete.



3.9 Adaption Procedure with Magnetic Compass Systems

Aquisition of Parameters

Carry out the following procedure to "finely tune" or optimize the adaptive parameters of the ship.

Calm weather during the adaption manoeuvre will provide fast and accurate aquisition of the ship's parameters.

Procedure

1. Select a manual steering mode.
2. Set the rudder limit to not less than 10 degrees.
3. If the ship's speed input is not automatic, enter the normal cruising speed manually.
4. The RATE/°min steering mode is required for the adaption procedure. If the RATE steering mode is not selected, enter the setup procedure (see 3.5) and press **ENTER** repeatedly until the *r d s* (radius) display appears.
5. Turn the control disk to change the display to *r A t e* (rate steering) and press **AUTO** to exit the setup procedure.
6. Press **ENTER** three times. The RATE/RADIUS steering parameter will flash.
7. Turn the control disk clockwise until the highest rate value is displayed e.g.80. For the adaption procedure select 50% of the highest rate value; in this example 40. 50 % of the highest rate value is, however, an approximation and it may be necessary to change it.
- 8.. Press **AUTO** to return to the previous operation mode.
9. Press simultaneously the keys **ENTER** **RESET** **DIM** to enter the setup procedure.
1/10° -
10. Press **ENTER** repeatedly until the *Ad_dM* display appears. *Ad_dM* is the rudder sensitivity parameter. Turn the control disk to bring the number displayed to 50, or alternatively, enter a value obtained from a sister ship. Press **ENTER** to store this value. The display will change to *Ad_6M* (6 = G = g).
11. *Ad_6M* is the gain parameter. Turn the control disk to bring the numbers displayed to 50, or alternatively, enter a value obtained from a sister ship. Press **AUTO** to store this value and exit to the previous operation mode.
12. Press **ENTER** twice. The *Steering Strategy* display will flash. Turn the control disk to select both *Confined Waters* and *Lock*. Press **AUTO** to take over the parameters from the setup procedure.



13. Select now the steering strategy *Confined Waters without Lock*.
14. Select the autopilot steering mode.
15. Press simultaneously **ENTER** and **AUTO** . The following displays will flash and show various adaption procedure related information:
 - **RUDDER LIMIT**
shows the current adaption status, which can be 0, 10, 20, 30, 35, or 38 [0 = no adaption, 10 = continue adaption procedure, 20 good adaption, 30, 35 and 38 = very good adaption].
 - **RATE / RADIUS**
shows the adaption parameter Ad_dM
 - **OFF COURSE ALARM**
shows a time countdown in seconds
 - **MAGNETIC VARIATION**
shows the adaption parameter Ad_gM
16. The current adaption status in the RUDDER LIMIT display must be 0 (zero) before the adaption procedure can be started. If the display is not 0, press **ENTER** and hold down, press **RESET** and hold down, press **AUTO** and hold down. Release all three keys simultaneously. The display in RUDDER LIMIT will now be 0 (zero).
17. Using the autopilot, change the set heading by +30°. The time countdown in the OFF COURSE ALARM window will first display 0 (zero). After a short time a number in seconds will appear (e.g. 10 or 35). Hold the +30° heading until the time countdown has reached 0 seconds. When possible, maintain the +30° heading for a further 5 minutes - this will shorten the adaption procedure. Now proceed to step 18.
18. Using the autopilot, change the set heading by -60°. The time countdown in the OFF COURSE ALARM window will first display 0 (zero). After a short time a number in seconds will appear (e.g. 10 or 35). Hold the -60° heading until the time countdown has reached 0 seconds. When possible, maintain the -60° heading for a further 5 minutes - this will shorten the adaption procedure. Now proceed to step 19.
19. Using the autopilot, change the set heading by +60°. The time countdown in the OFF COURSE ALARM window will first display 0 (zero). After a short time a number in seconds will appear (e.g. 10 or 35). Hold the +60° heading until the time countdown has reached 0 seconds. When possible, maintain the +60° heading for a further 5 minutes - this will shorten the adaption procedure. Now proceed to step 20.



20. Using the autopilot, change the set heading by -30° . The time countdown in the OFF COURSE ALARM window will first display 0 (zero). After a short time a number in seconds will appear (e.g. 10 or 35). Hold the -30° heading until the time countdown has reached 0 seconds. When possible, maintain the -30° heading for a further 5 minutes - this will shorten the adaption procedure. then Now proceed to step 21.
21. If the adaption status (in the RUDDER LIMIT window) is 20 or higher, proceed to step 22.
If the adaption status is less than 20, carry out further manoeuvres as described in the sequence above.
When the adaption status has reached at least 20, proceed to step 22.
22. Make a note of the adaption values as displayed: Ad_dM (RATE/RADIUS), Ad_gM (MAGNETIC VARIATION).
23. Press **ENTER** and **AUTO** simultaneously. The display will return to the normal operational mode and display again all the steering parameters.
24. Select a manual steering mode (FU or NFU).
25. Press simultaneously the keys **ENTER**, **RESET** and **DIM** to enter the setup mode.
 $1/10^\circ$ -
26. Press **ENTER** repeatedly until **Ad_dM** is displayed. Turn the control disk cw or ccw to enter the value recorded for the Ad_dM parameter.
27. Press **ENTER** once to display the **Ad_gM** parameter value. Turn the control disk cw or ccw to enter the value recorded for the Ad_gM parameter.
28. Press **AUTO** to return to the normal autopilot operation mode; the adaption procedure is now complete.

3.10 Display of Software Version

1. Select a manual steering mode.
2. Press simultaneously the keys **ENTER**, **RESET** and **DIM** to enter the setup procedure.
 $1/10^\circ$ -
3. Press **AUTO** to exit the setup procedure. The software version is shown in the display for approximately two seconds.



3.11 Autopilot Error Codes

When an alarm is given (e.g. INTERFACE HDG) press **ALARM** **1/10°** to switch off the audible alarm.

To view the associated error code number, simultaneously press and hold down **DIM** and **DIM** the error code number will appear in the *SET HDG* display.

+

-

The error code number will be displayed as long as **DIM** and **DIM** remain pressed.

+

-

NOTE: During this time make a note of the error code number, as it will not be possible to view the error code number for a second time without deenergizing and re-energizing the autopilot.

As soon as **DIM** and **DIM** are released, the error code number will disappear.

+

-

If **DIM** and **DIM** are pressed again, either the next error code number

+

-

(when more than one than one fault is present) will be shown in the *SET HDG* display or three times the eight - *888* - to indicate the end of the list of error code numbers. Further attempts to view again the error code numbers by pressing **DIM** and **DIM** will result in *888* being shown in the *SET HDG*

+

-

display and it will be necessary to deenergize and re-energize the autopilot in order to see again the error code numbers.

The error code numbers are listed on the following page.

NOTE: If error code 78 is displayed, deenergize the autopilot to cancel the alarm. After a time elapse of 15 seconds, re-energize the autopilot.

TIMEOUT VALUES

Count	Waiting Time in Seconds	Interface
30	15	Start of NMEA reception
20	10	NMEA NAV mode messages
16	8	PLATH ACT HDG RS 422 gyrocompass
10	5	NMEA ACT HDG messages
10	5	Remote unit timeout
30	15	START speed input interface timeout
10	15	Speed input interface timeout



Error Code	Error	Cause/Correction
------------	-------	------------------

FATAL ERRORS

128	divided by 0	program error / switch off , switch on
129	stack overflow	
130	EEPROM write error in Setup data	write cycles exceed limit, replace EEPROM
131	Stack underflow	
132	5 volt < 4.75 or > 5.25 volt	check power supply
133	12 volt < 11.0 or > 13.0 volt	check power supply
134	spare	
135	spare	
136	spare	
137	message buffer overflow	program error
138	process nonexistent	
139	spare	
140	EEPROM parameter write error	last alternative block written, replace EEPROM
141	network receivers timeout	failure in network to repeaters
142	display overflow	program error (number too large for display)

NON-FATAL ERRORS

065	spare	
066	GYRO INTERFACE FAILURE (HHH or LLL)	
067	spare	
068	keyboard repeat error	key is jammed
069	program error	process status switching error
070	EEPROM process overrun	timing error
071	spare	
072	spare	
073	voltage error in sin/cos from magnetic compass	sin/cos voltage at A/D converter illegal
074	spare	
075	spare	
076	timeout NMEA interface	no valid (error-free) NMEA sentence received
077	timeout RS 422 compass interface	no valid (error-free) compass sequence received
078	timeout LOCAL NET	repeaters
079	heading difference between gyro and magnetic compass exceeds off course alarm	
080	timeout NMEA magnetic (RS 422)	
081	timeout speed interface	
082	Lehmkuhl LR 40 alarm state	
083	Lehmkuhl LR 40 phys i/o	
084	Lehmkuhl LR 40 Timeout	
085	timeout NMEA gyrocompass RS 422	
086	speed via 200 pulse/NM < min speed (no error, only warning)	

WARNINGS

001	unable to write in EEPROM	
002	unable to read from EEPROM	
003	operating error incorrect function	short flash of text <i>FAILURE</i>
004	RS 422 NMEA checksum error	short flash of <i>NMEA INTERFACE FAILURE</i>
005	RS 422 Compass checksum error	short flash of <i>HDG INTERFACE FAILURE</i>
006	device error RS 422 compass received	short flash of <i>HDG INTERFACE FAILURE</i>
007	180° turn still active	short flash of <i>FAILURE</i> , turn still > 180°, wait
008	incorrect operation mode for 180° turn	short flash of <i>FAILURE</i> , change mode e.g. MAN to AUTO
009	gyro out signal overflow	change in course too fast (rate of turn)
010	spare	
011	RS 422 NMEA magnetic compass checksum/format error	
012	5 volt failed	
013	12 volt failed	
014	compass change in AUTO/NAV mode	



3.12 Power-Up Test

During Power Up of NAVIPILOT AD II, several tests are carried out automatically. The test numbers are shown in the SET HDG window and the associated error codes in the ACT HDG window.

If an error is detected during the power up test, the test number and the associated error code are displayed permanently. The test program will continue, regardless of an error, when ENTER is pressed.

During the Power Up Test, the following functions are checked.

1. ROM checksum test.
ROM test failed: audible alarm sounds continuously.
2. RAM read and write test.
RAM test failed: audible alarm on/off/on/off
3. For visual test purposes, all display segments of the liquid crystal display are shown for approximately 3 seconds.
4. Display of the software release number in the ACT HDG window and of the sub-release code in the MAGNETIC VARIATION window.
5. Test No. 1 VOLT Test:
0 : supply voltage o.k.
5 : 5 volt outside specified range.
12: ±12 volt outside specified range
6. Test No. 2 Keyboard Test:
0: no key pressed.

Key code for pressed or jammed Key(s):

- 1 key AUTO
- 2 key NAV
- 4 key RUDDER LIMIT OFF
- 8 key ENTER
- 16 key ALARM RESET
- 32 key DIM -
- 64 key DIM +

If more than one key is jammed, the error codes are added, for example: Code 66 = 64+2, i.e. jammed keys are DIM - and NAV.



7. Test No. 3 Serial Communication:
0: UART o.k.
1: input/output error local net.

Additional display of the remaining storage capacity of the EEPROM in the window MAGNETIC VARIATION:

- 0: no use of alternative memory.
1 - n: after write errors, use of alternative memory for the nth time.

8. Test No. 4 Input/output Port Configuration (only at the controller):
0: port values read are plausible.
1: function AUTO selected at power up.
2: no legal function read.

NOTE: The software release number is also displayed when the SETUP procedure is exited (reset).

To read the software release number without having to switch the autopilot on and off, press simultaneously ENTER ALARM DIM to enter
RESET -
the SETUP procedure.

Press AUTO to exit the SETUP procedure, the software release number will be displayed for approximately two seconds in the ACT HDG window.



3.13 Correction Table for the Heading from the Magnetic Compass

Magnetic Compass Heading	Heading on Pilot before Correction	Correction Value
10°		
20°		
30°		
40°		
50°		
60°		
70°		
80°		
90°		
100°		
110°		
120°		
130°		
140°		
150°		
160°		
170°		
180°		
190°		
200°		



Magnetic Compass Heading	Heading on Pilot before Correction	Correction Value
210°		
220°		
230°		
240°		
250°		
260°		
270°		
280°		
290°		
300°		
310°		
320°		
330°		
340°		
350°		
360°		



4. VOYAGE DATA RECORDER

4.1 General

The autopilot may be supplied with a voyage data recorder, which provides the operator with a graphic record of the vessel's course and rudder angle, and also prints at the beginning of each page, also when a parameter (e.g. off course alarm) is altered, in one horizontal status line the following operational data (from left to right):

DATE DD.MM.YY

LAT: 53 35.05N LON: 08 10.54E (only when the compass monitor NAVITWIN II is included in the system)

ST.M:N steering mode, **M** = MAN, **A** = AUTO, **N** = NAV

HDG:G heading source, **G** = gyro, **M** = magnetic

SET-HDG:000.0 set heading at the time of recording

RL:35 rudder limit: 35° *

ST.STR:CW steering strategy, CW = Confined Waters *
OS = Open Sea, RS = Rough Sea

ROT: or RDS: selected rate of turn or radius during course change *

SPD:12.7 ship's speed in knots *

OCA:35 angle for external off course alarm: 35°

D:80 } ship's parameters as stored after sea trials *
G:105 }

TAU:10 the ship's time constant factor tau

TIME over the time column

* Not shown on the printout examples on pages 4-02 through 4-06.

4.2 Operational Data

Paper feed speeds: 60 mm/h
150 mm/h
600 mm/h

Heading recording range: $\pm 30^\circ$ } over the same width of paper.
or $\pm 180^\circ$ }

Rudder angle recording range: $\pm 9^\circ$, $\pm 45^\circ$ or $\pm 70^\circ$

For selection of the above, refer to the autopilot Setup Procedure in section 3 of this manual.



4.3 Paper Feed Speeds and Rudder Angle Ranges

4.3.1 60 mm/h Paper Feed Speed, ±45° Rudder Angle Range

A paper feed speed of 60 mm/h and a rudder angle range of ±45° are recommended for normal operational conditions. Time increments are 15 min. each.

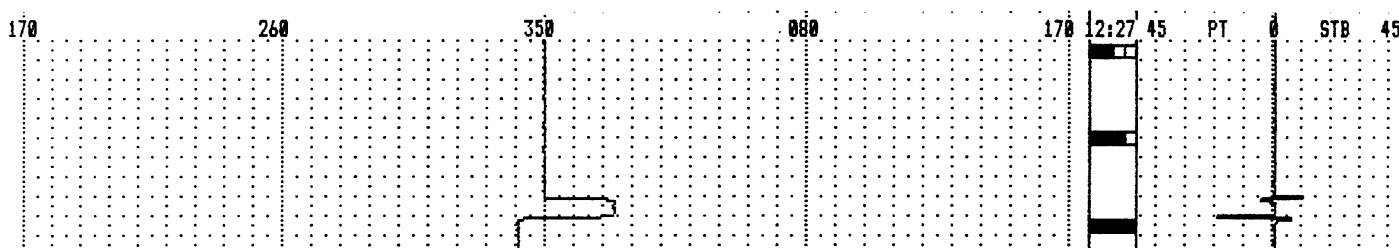

Please Note:

	15 min.
	30 min.
	45 min.
	60 min.

4.3.2 150 mm/h Paper Feed Speed, ±45° Rudder Angle Range

Provides increased resolution for the course recording. The rudder angle range remains the same as in 4.3.1. Time increments are 5 min.

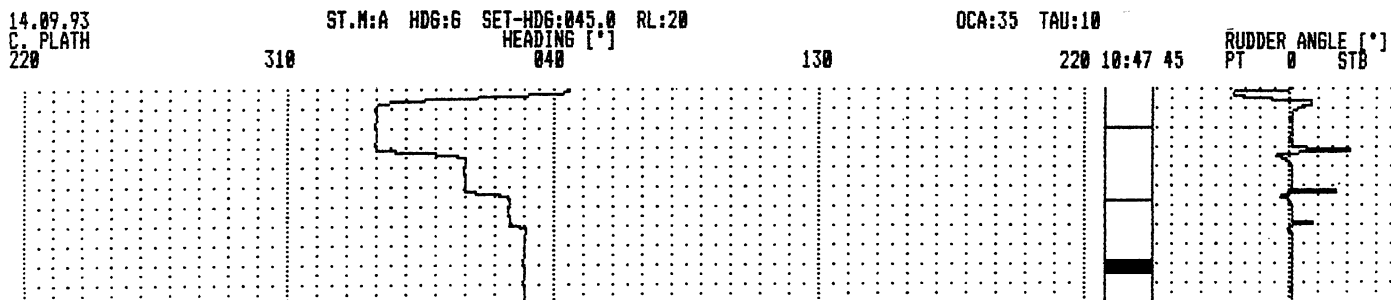

Please Note:

	15 min.
	30 min.
	45 min.
	60 min.



4.3.3 600 mm/h Paper Feed Speed, $\pm 45^\circ$ Rudder Angle Range

Provides a high resolution course recording.
Time increments are 1 min.

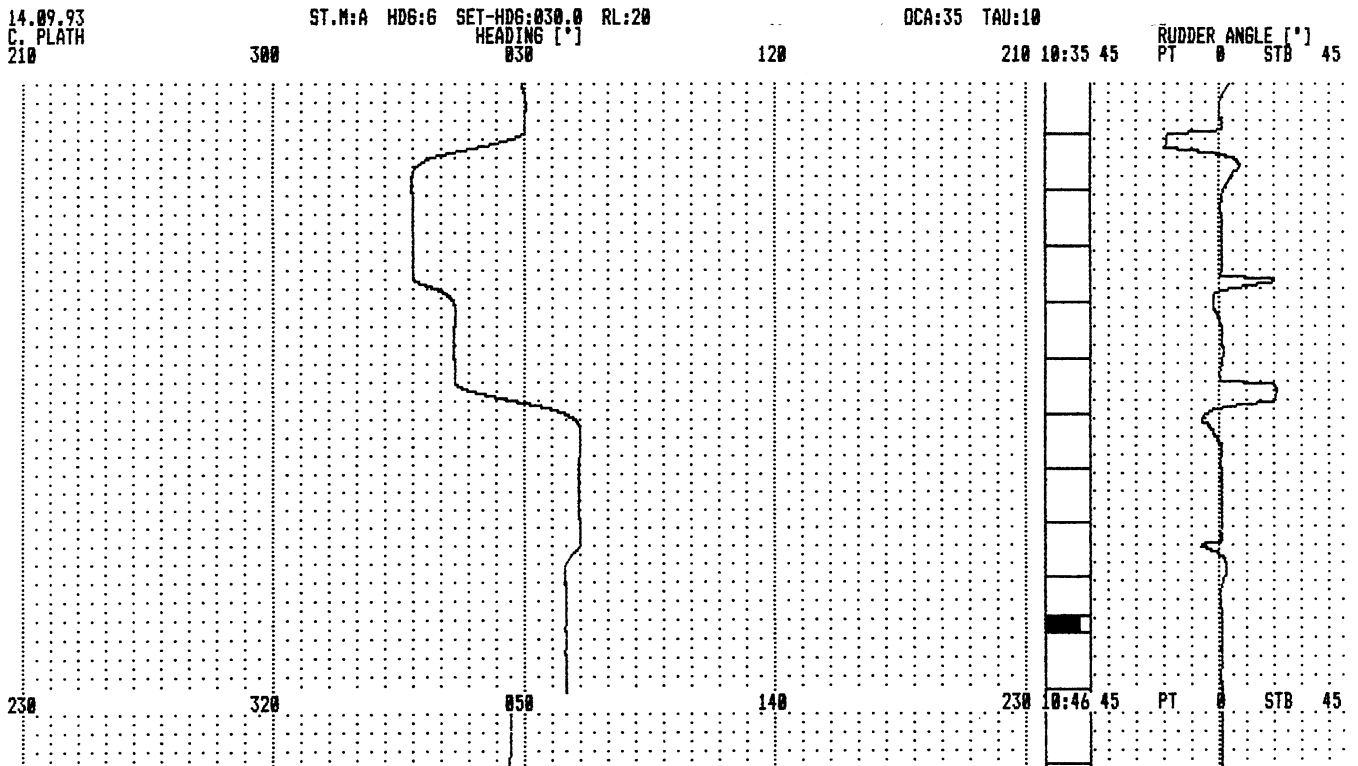

Please Note:

	15 min.
	30 min.
	45 min.
	60 min.



4.3.4 Zoom Function

In order to analyze in detail the vessel's steering characteristics (in both autopilot and manual steering modes) the zoom function provides the operator with the following high resolution recording ranges:

- paper feed speed 600 mm/H
- course recording range $\pm 30^\circ$
- rudder angle range $\pm 9^\circ$
- time increment 1 min.

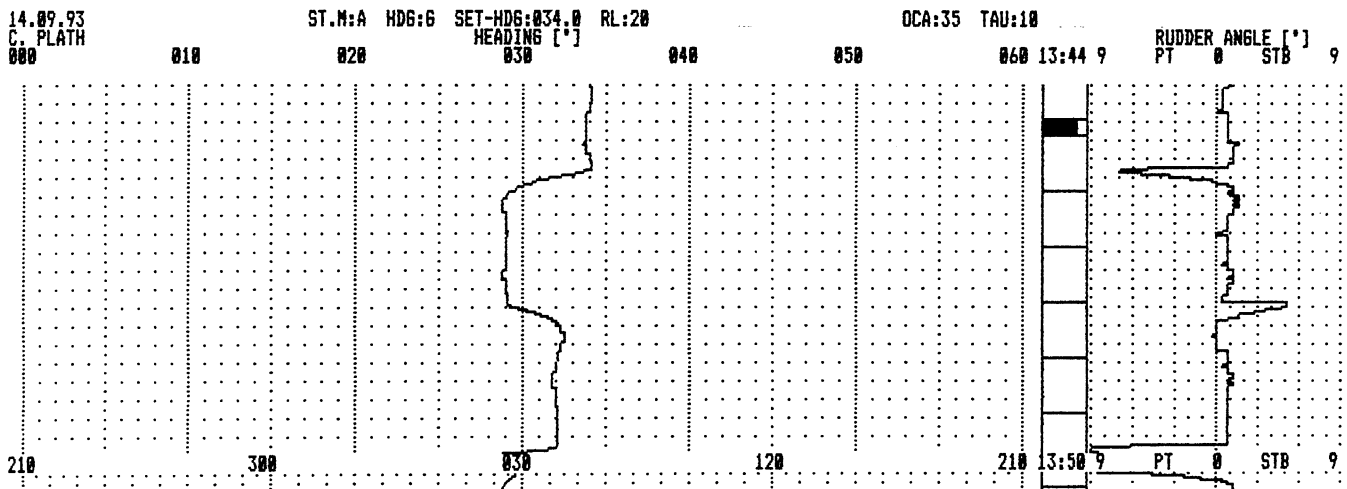

Please Note:

	15 min.
	30 min.
	45 min.
	60 min.



4.3.5 Scale Shift

When the course recording line reaches the margin of the scale, the voyage data recorder automatically shifts the scale to bring the course recording line back into the center of the scale, see example below.

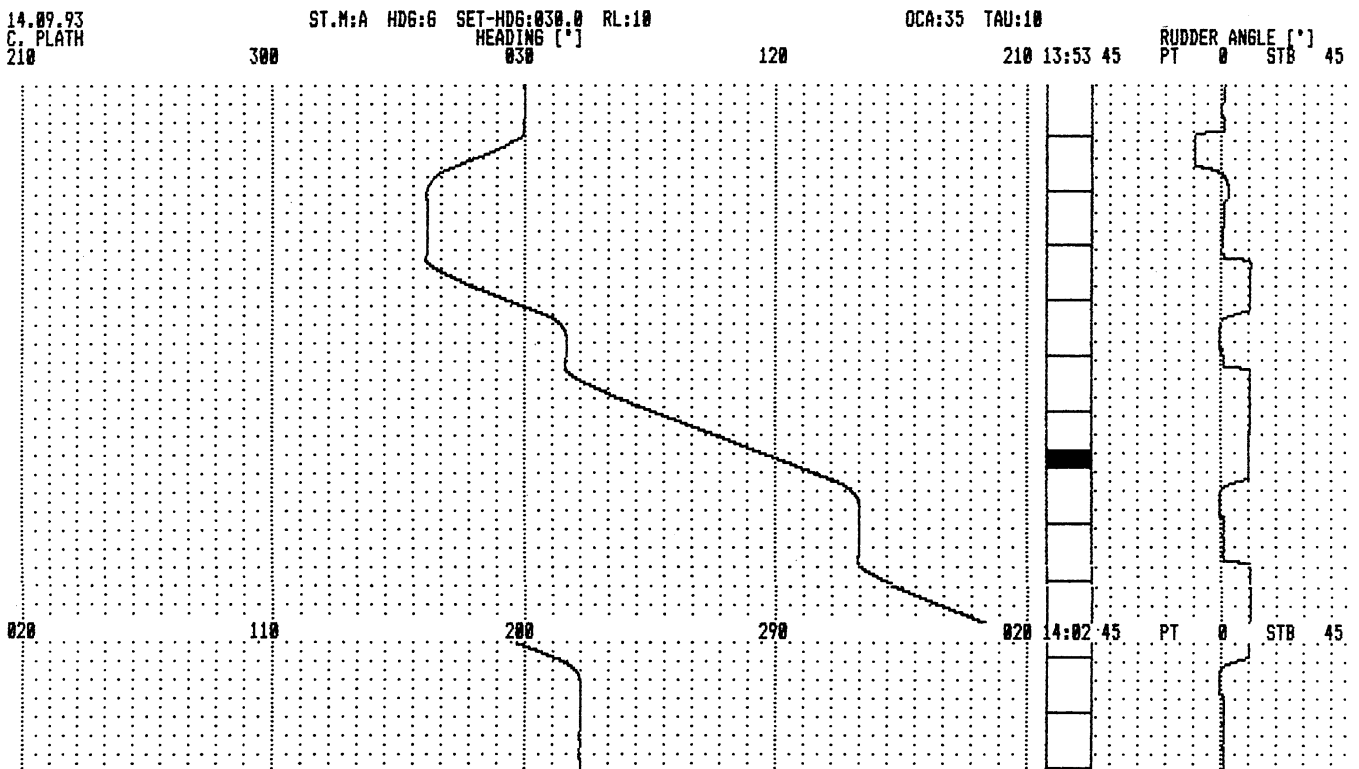



4.3.6 The Status Line

The status line is printed at the beginning of each new page, and additionally when a steering parameter is altered, e.g. RL (rudder limit) from 10° to 25° as shown in the example below.

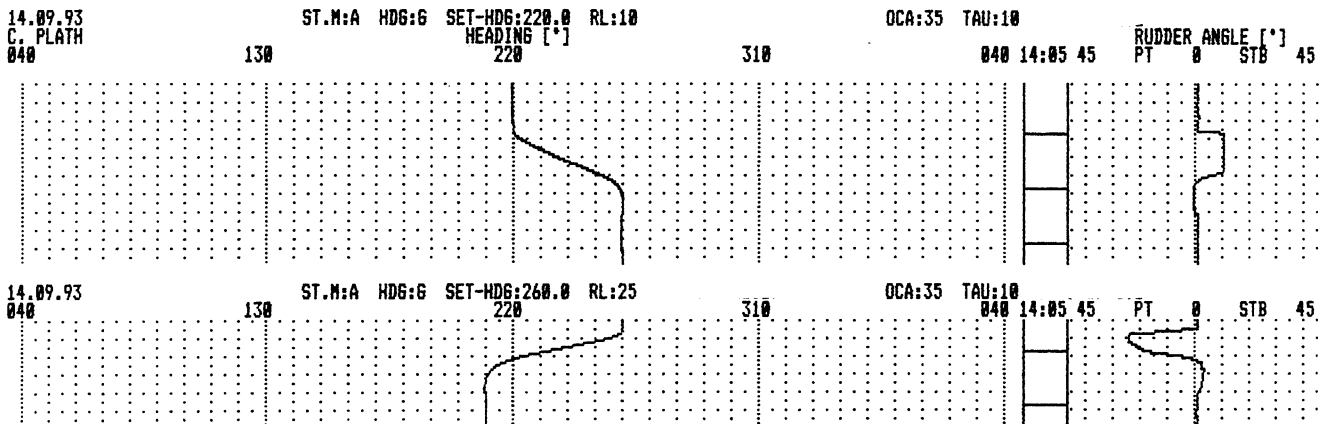

4.3.7 Time Printout

The time printout by the Voyage Data Recorder is dependent on the electronic clock in the autopilot or the compass monitor NAVITWIN II (when part of the system) according to which is used to supply information to the voyage data recorder.

At regular intervals the time printout is to be compared with the current time and amended when necessary.

The time is amended by correcting the time display in the setup procedure of either the autopilot or the compass monitor NAVITWIN II. Refer to the section covering the setup procedure in the relevant operator's manual.

NOTE: After a blackout or power failure of the autopilot and/or compass monitor, the time and date will have to be reset. Refer to the section covering the setup procedure in the relevant operator's manual.

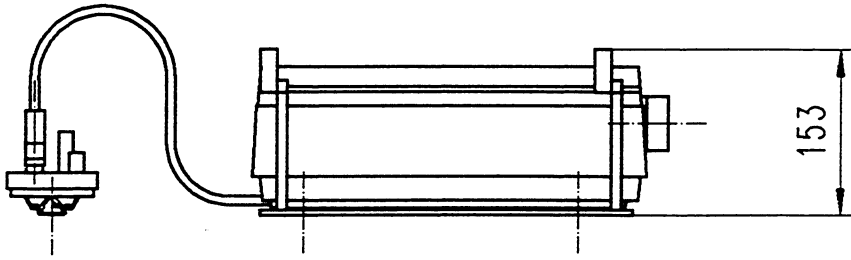

Maße für Klemmleiste
siehe Blatt 2
Dimensions for
Terminal Board see Page 2

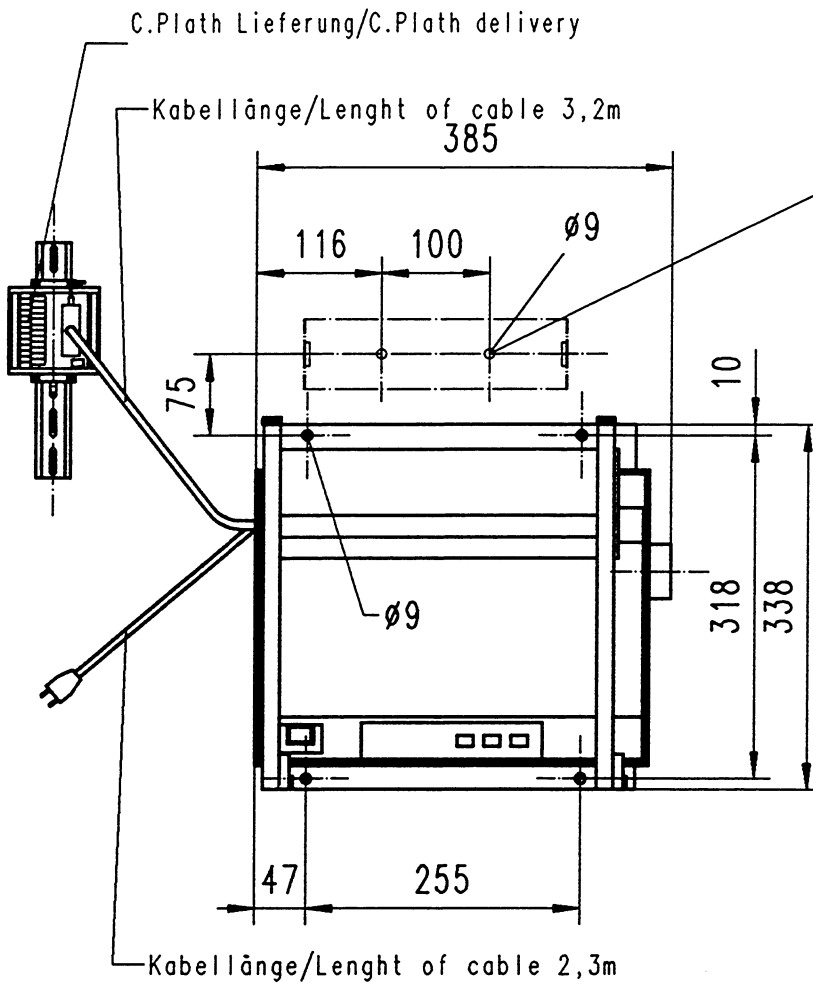

Gewicht/Weight 8 kg.

CAD

© (C.PLATH 29.11.1994)

REV	MOD.NO.	DATE	NAME	Maßstab/SCALE	DATE	NAME	Maßzeichnung / DIMENSION DRAWING	
				/	DRAWN 29.11.1994	Kie	Fahrdatenschreiber Voyage Data Recorder	
				4805m031.dxf	CHD			1
					DOS	NMHBSNEE		Blattz. SHEETS
				Zeichnungs Nr./Drawing No.				3
				4805-0112-03				
				C. PLATH HAMBURG				
				Lager Nr./STOCK NO. 74489			REPLACEMENT FOR:	

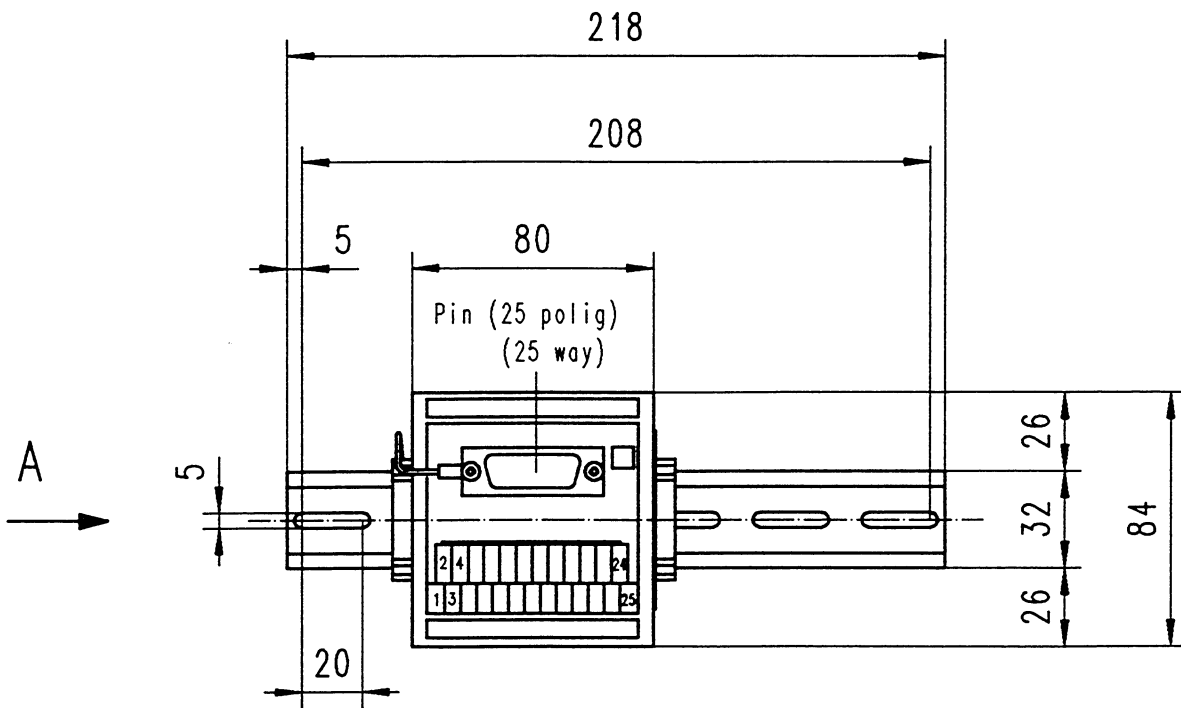

Kabellänge 3,2m (C.Plath Lieferung)
 Length of cable 3,2m (C.Plath delivery)

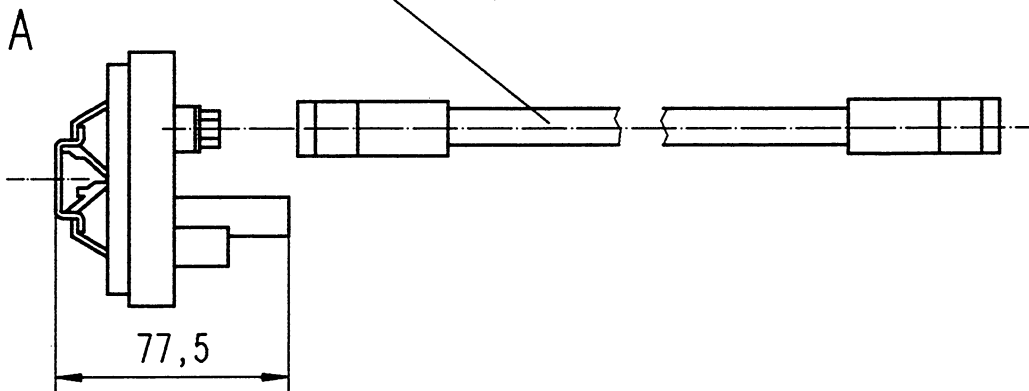

Gewicht/Weight 0,6 kg.

© (C.PLATH 29.11.1994)

				Maßstab/SCALE	DATE	NAME	Maßzeichnung / DIMENSION DRAWING	
				/	DRAWN	29.11.1994	Fahrdatenschreiber Voyage Data Recorder	
					CHD			
					4805m032.dxf	DOS		
AC	99761	09.06.97	Ho.	Zeichnungs Nr./Drawing No.				Klemmenleiste Terminal Board
AB	99761	09.06.97	Ho.	4805-0112-03			SHEET	
AB	99734	07.03.97	Ho.	C. PLATH HAMBURG			2	
AA	-	29.11.94	Kie					Blattz.
REV	MOD.NO.	DATE	NAME	Lager Nr./STOCK NO.			REPLACEMENT FOR:	3

Wand Montage
Wall mounting

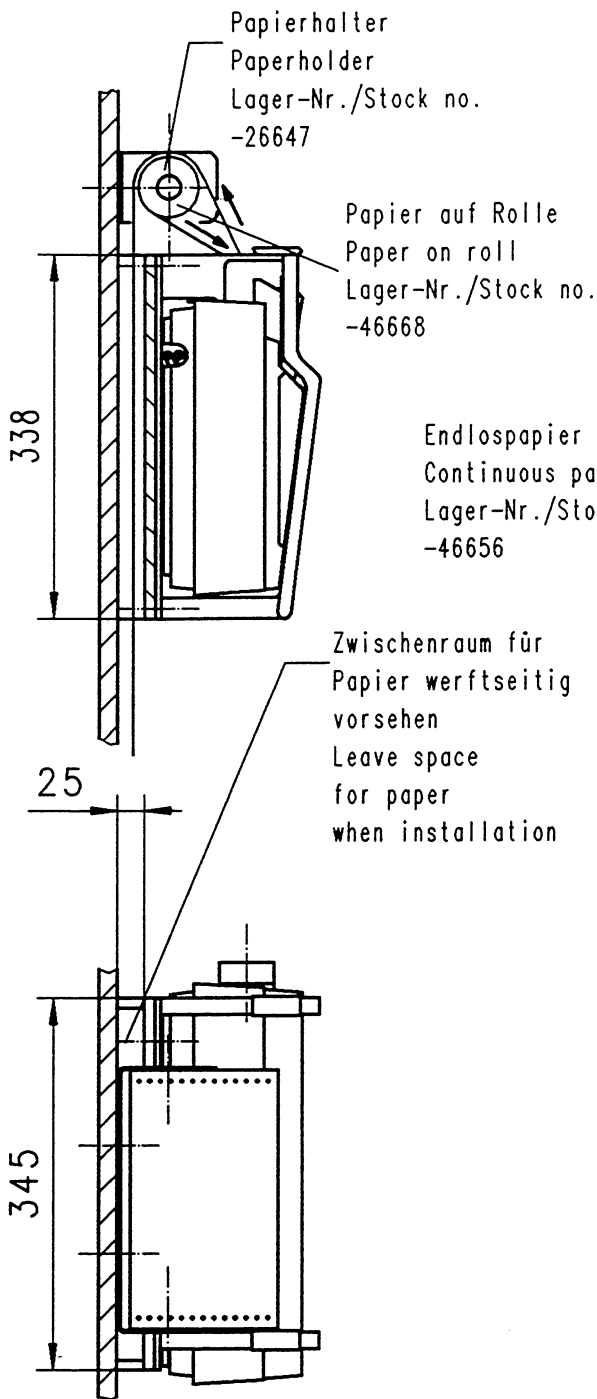

Tisch Montage
Desk mounting

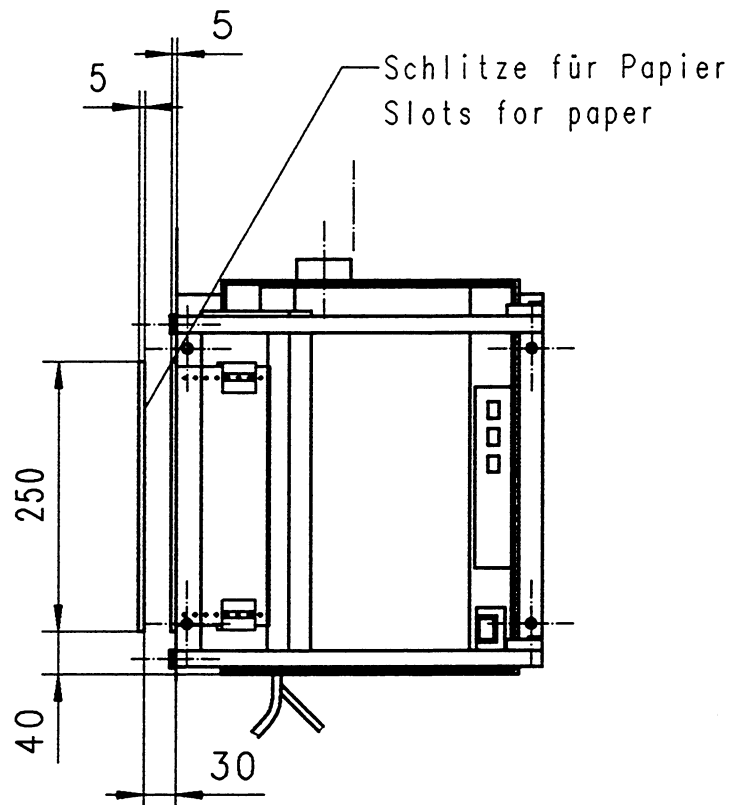
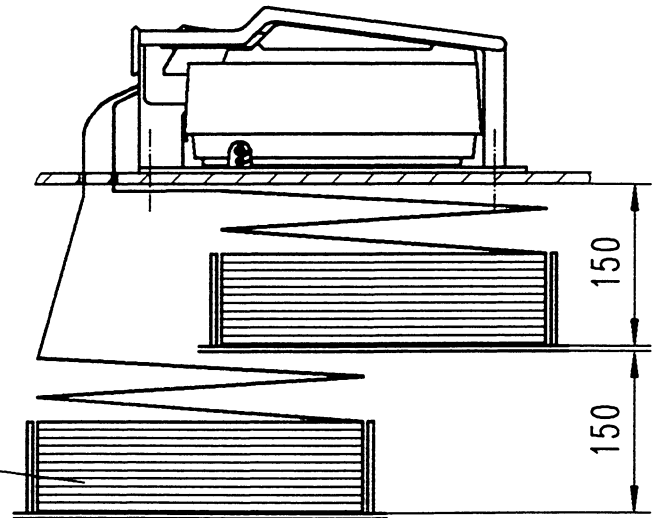

© (C.PLATH 29.11.1994)

CAD

				Maßstab/SCALE	DATE	NAME	Maßzeichnung / DIMENSION DRAWING	
				/	DRAWN 29.11.1994	Kie		
				4805m033.dxf	DOS	NMHBSNDW	Fahrdatenschreiber Voyage Data Recorder Empfohlener Einbau Recommended method of installation	Blatt SHEET 3 Blattz. SHEETS 3
				Zeichnungs Nr./Drawing No.				
AC	99761	09.06.97	Ho.	4805-0112-03				
AB	99734	07.03.97	Ho.	C. PLATH HAMBURG				
AA	-	29.11.94	Kie	Lager Nr./STOCK NO.			REPLACEMENT FOR:	

LITTON

C. PLATH
NAVIGATION-AUTOMATION

Number	Rev.	sheet:	01
4791-0120-01	AA	of:	01

Description : INTERFACE SPECIFICATION, VERZEICHNIS

INTERFACE SPECIFICATIONEN FÜR NAVIPILOT ADII

4791-0120-02 NAVIPILOT ADII
4791-0120-03 NAVIPILOT ADII - NACOS 10
4791-0120-04 NAVIPILOT ADII - INS
4791-0120-05 NAVIPILOT ADII - NAVIPILOT I
4791-0120-06 NAVIPILOT ADII - SELESMAR / VECTOR
4791-0120-07 NAVIPILOT ADII - NORCONTROL / DB2000

Use of document data is subject to the restrictions of page 1



Serial-Interface-Specification:

1. Navigation-Receivers (NAV):

Format: NMEA 0183
Baudrate: 4800 bps
Data bits: 8
Parity bits: none (disabled)
Stopbits: 1 or 2
Checksum: CS or no CS accepted

- 1.1 \$--HSC,x.x,T,x.x,M*CS<CR><LF>
- 1.2 \$--BOD,x.x,T,x.x,M,c--c,c--c*CS<CR><LF>
\$--XTE,A,A,x.x,a,N*CS<CR><LF>
- 1.3 \$--APA,A,A,x.x,a,N,A,A,x.x,a,c--c*CS<CR><LF>
L M or T
- 1.4 \$--APB,A,A,x.x,a,N,A,A,x.x,a,c--c,x.x,a,x.x,đ*CS<CR><LF>
- 1.5 \$--CTS,xxx,T*CS<CR><LF>
- 1.6 \$--PCT,xxx.x,T*CS<CR><LF>
- 1.7 \$--BPI,,,a,,a,x.x,T,x.x,M,,N,c--c*CS<CR><LF>
- 1.8 \$--BWR,,,a,,a,x.x,T,x.x,M,,N,c--c*CS<CR><LF>
- 1.9 \$--BWC,,,a,,a,x.x,T,x.x,M,,N,c--c*CS<CR><LF>

2. Electronic Compass (Heading magn.):

- 2.1 \$--HDM,x.x,M*CS<CR><LF> update rate < 200 ms

3. Remote Units:

Format: RS422 C. Plath specific
Baudrate: 9600 bps
Databits: 8
Parity bits: none (disabled)
Startbits: 1
Stopbits: 2

Protocol Data: Heading Gyro, Heading Magnetic,
Set Heading, Speed, LCD-Data

4. Heading/Ruder Angle-Printer:

Format: RS422 C. Plath specific



Serial - Interface - Specification

NAVIPILOT AD II <—> NACOS 10

Baudrate : 4800 bps
Data bits : 8
Parity bits : none (disabled)
Stopbits : 1

Format : NMEA 0183

NAVIPILOT AD II —> NACOS 10
Driver : RS 422

Autopilot System Data

Transmission rate : 1 protocol per second

\$AGASD,x.x,x.x,a,x.x,A,,,x.x,x,x,A*hh<CR><LF>

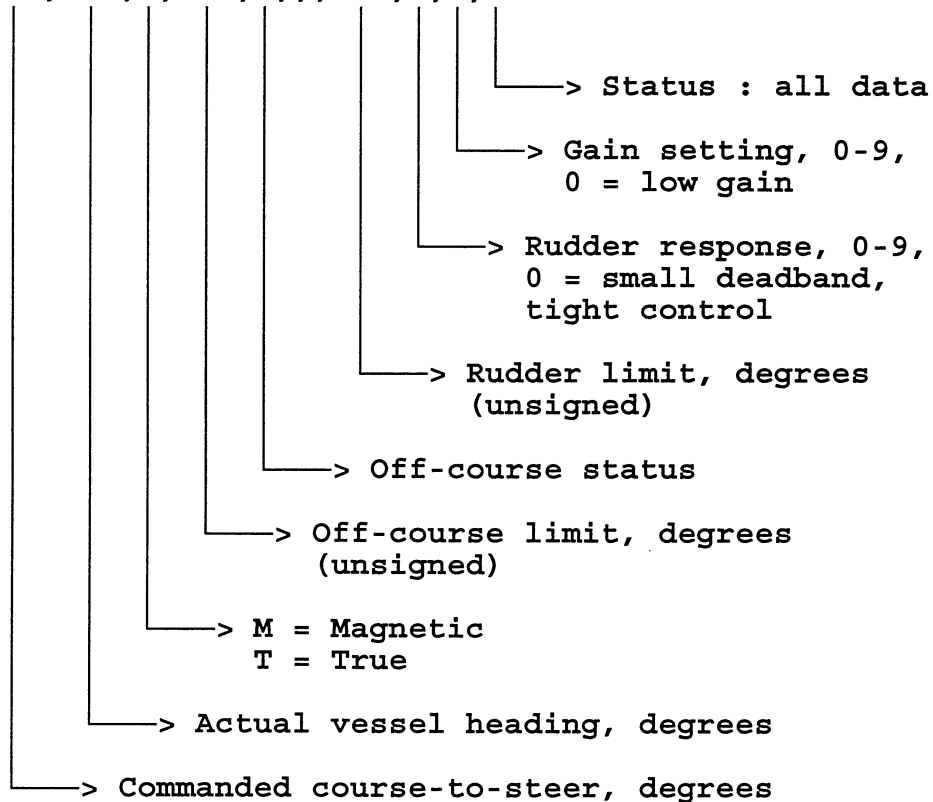



Radius

Transmission rate : 1 protocol per second

\$PPRDS,x.x,N,A*hh<CR><LF>

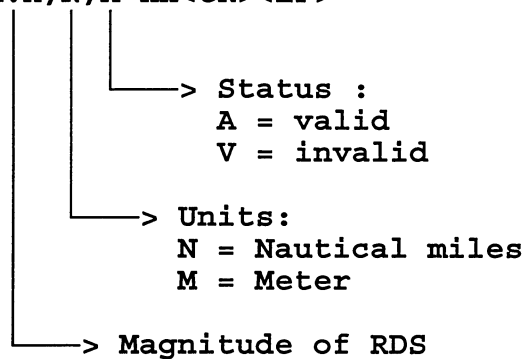

NAVIPILOT AD II has stored the time constant of the ship and calculates the smallest RADIUS (Rmin) to which the ship can steer.

If the magnitude of the RADIUS transmitted from NACOS10 is $\geq R_{min}$, NAVIPILOT AD II confirms the RADIUS and sets the status byte to 'A'.

If the transmitted magnitude is $< R_{min}$, NAVIPILOT AD II will transmit Rmin and set the status byte to 'V'. The function of NAVIPILOT AD II will not be impaired.

Navigation Status Data

Transmission rate : 1 protocol per second

\$PPNSD,A,A,,A,A,,,A*hh<CR><LF>

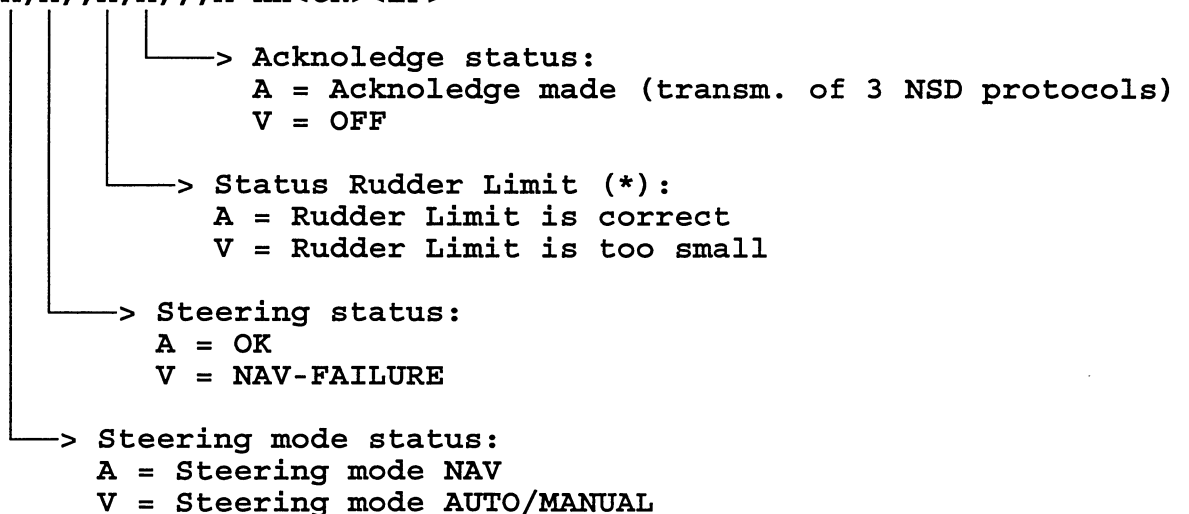



- * If the magnitude of RUDDER LIMIT on NAVIPILOT AD II is set to the necessary value, NAVIPILOT AD II confirms the RUDDER LIMIT by setting the status byte to 'A'.
If, during a track-course change, the ship does not reach the necessary turn rate for the radius transmitted from the NACOS10 and the turn rate ceases to increase, NAVIPILOT AD II will set the RUDDER LIMIT status byte to 'V'.

These protocols are transmitted continuously in the steering modes AUTO and NAV.



NACOS 10 —> NAVIPILOT AD II
Driver : RS 422

Autopilot Sentence "B"

Transmission rate : 1 protocol per second

\$INAPB,A,A,x.x,a,N,A,A,x.x,a,,x.x,a,,*hh<CR><LF>

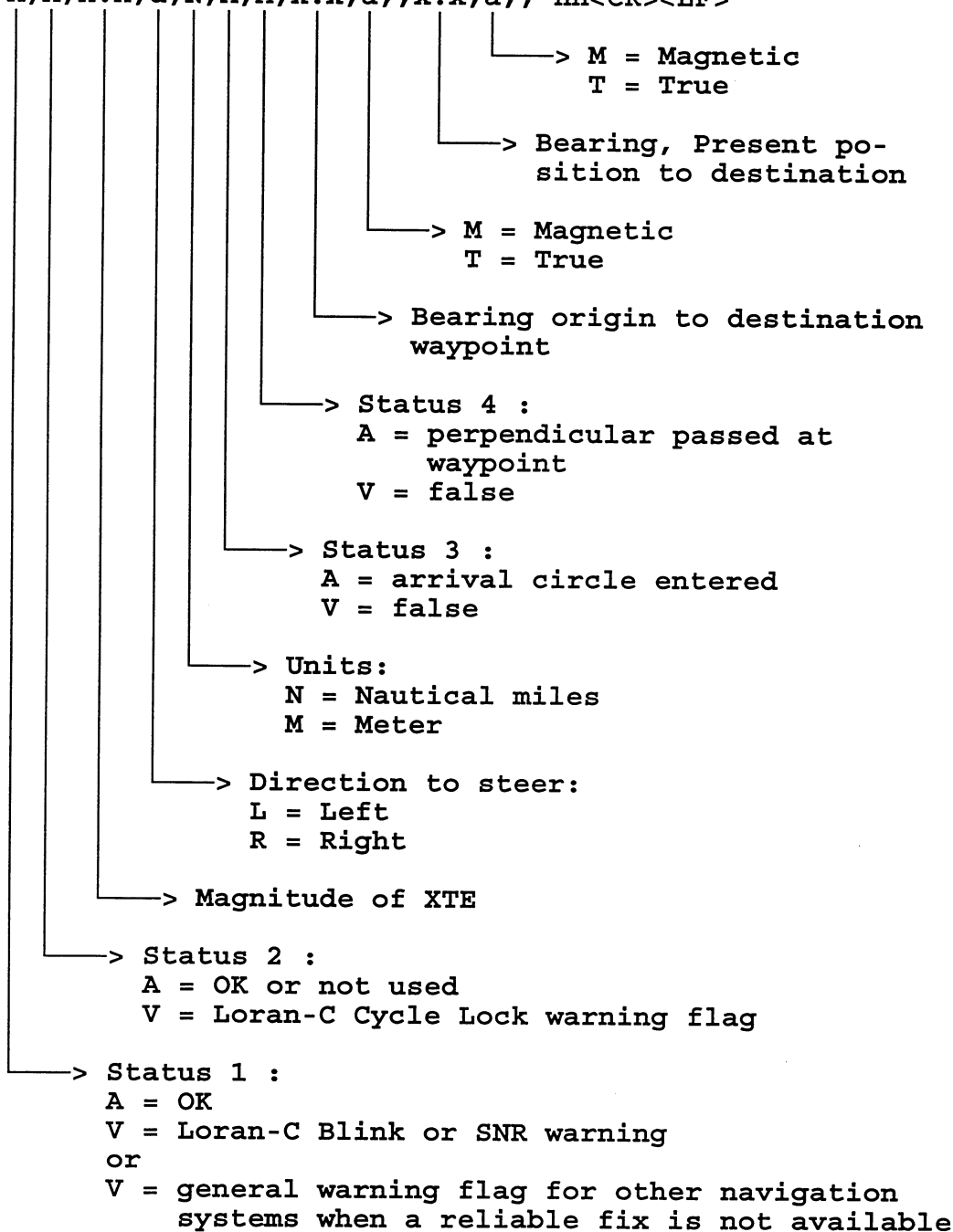



If GPS fails status byte 1 is set to 'V' and XTE is no longer available. In this case the 'bearing origin to destination waypoint' (track course) without XTE is used for 'NAV-SET-COURSE' of NAVIPILOT AD II.

Time to Wheel-Over Point

Transmission rate : 1 protocol per second

\$PPTW,m.ss,A*hh<CR><LF>

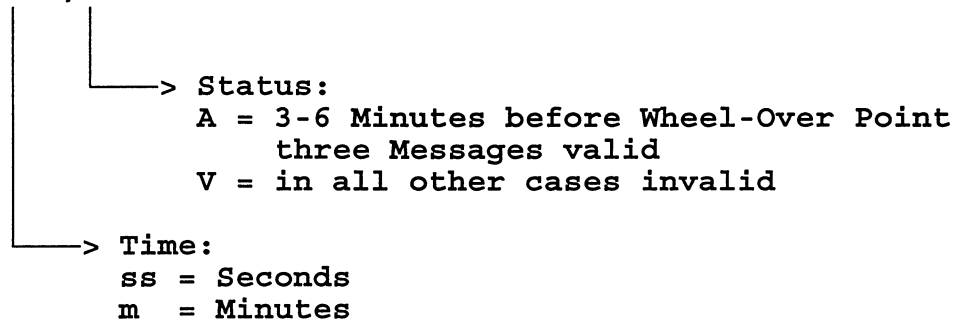

Radius

Transmission rate : 1 protocol per second

\$PPRDS,x.x,N,A*hh<CR><LF>

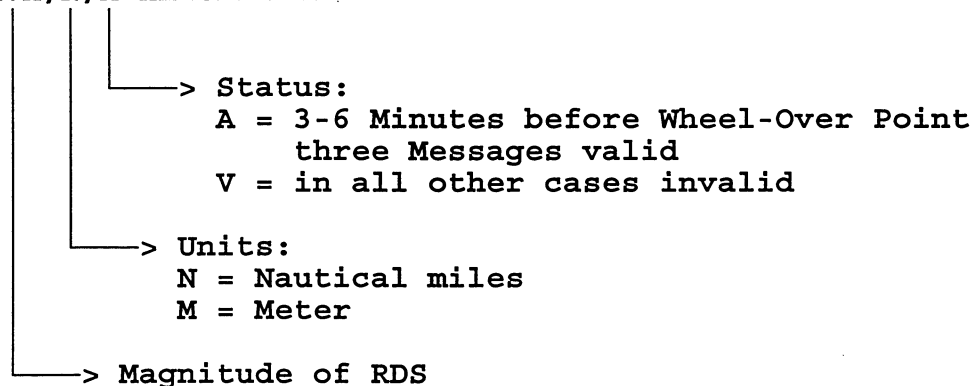



Navigation Status Data

Transmission rate : 1 protocol per second

\$PPNSD,,A,W,,,,,A*hh<CR><LF>

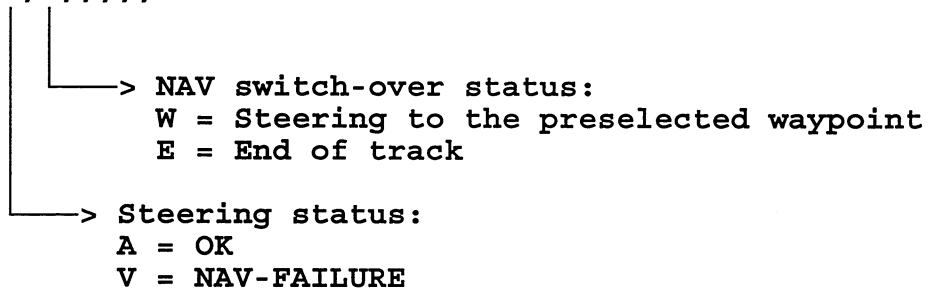

These protocols are transmitted continuously in steering mode NAV.



Serial - Interface - Specification

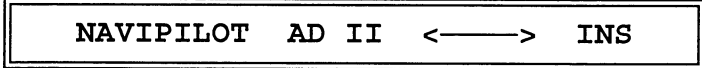

Variant 3

Baudrate : 4800 bps
Data bits : 8
Parity bits : none (disabled)
Stopbits : 1

Format : NMEA 0183

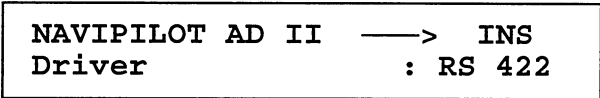

Autopilot System Data

Transmission rate : 1 protocol per second

\$AGASD,x.x,x.x,a,x.x,A,,,x.x,x,x,A*hh<CR><LF>

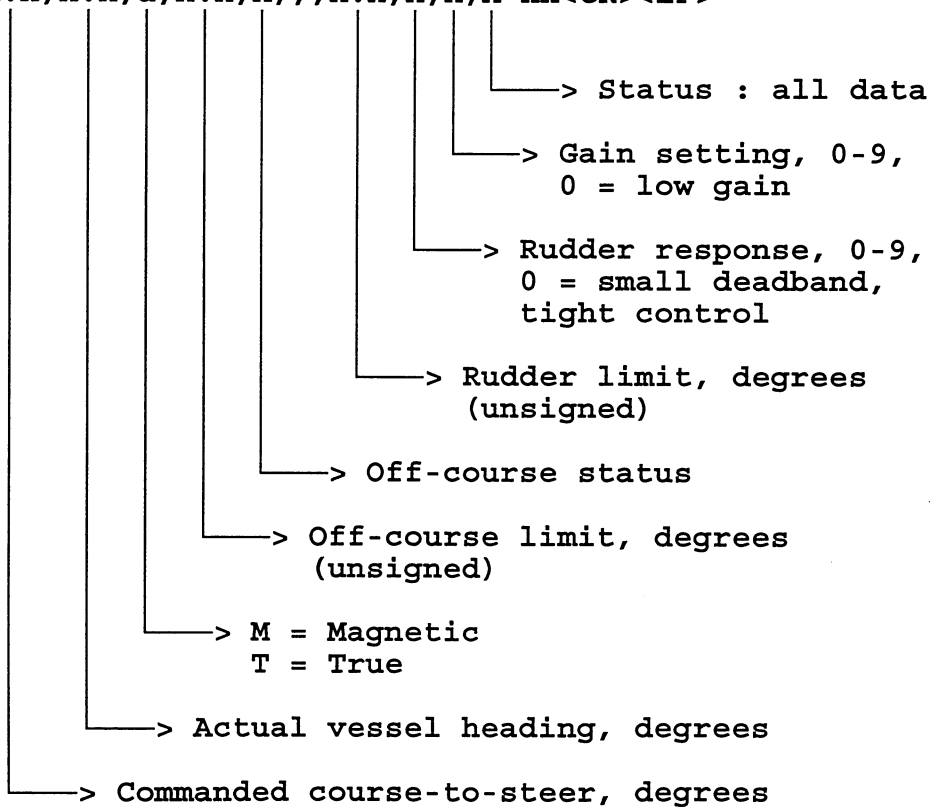



Radius

Transmission rate : 1 protocol per second

\$PPRDS,x,x,N,A*hh<CR><LF>

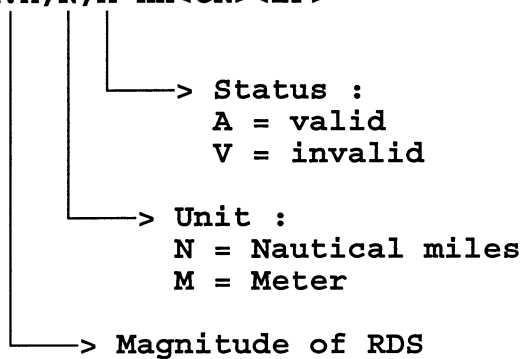

NAVIPILOT AD II has stored the time constant of the ship and calculates the smallest RADIUS (Rmin) to which the ship can steer.

If the magnitude of the RADIUS transmitted from the INS is \geq Rmin, NAVIPILOT AD II confirms the RADIUS and sets the status byte to 'A'.

If the transmitted magnitude is $<$ Rmin, NAVIPILOT AD II will transmit Rmin and set the status byte to 'V'. The function of NAVIPILOT AD II will not be impaired.

Navigation Status Data

Transmission rate : 1 protocol per second

\$PPNSD,A,A,,A,A,,,*hh<CR><LF>

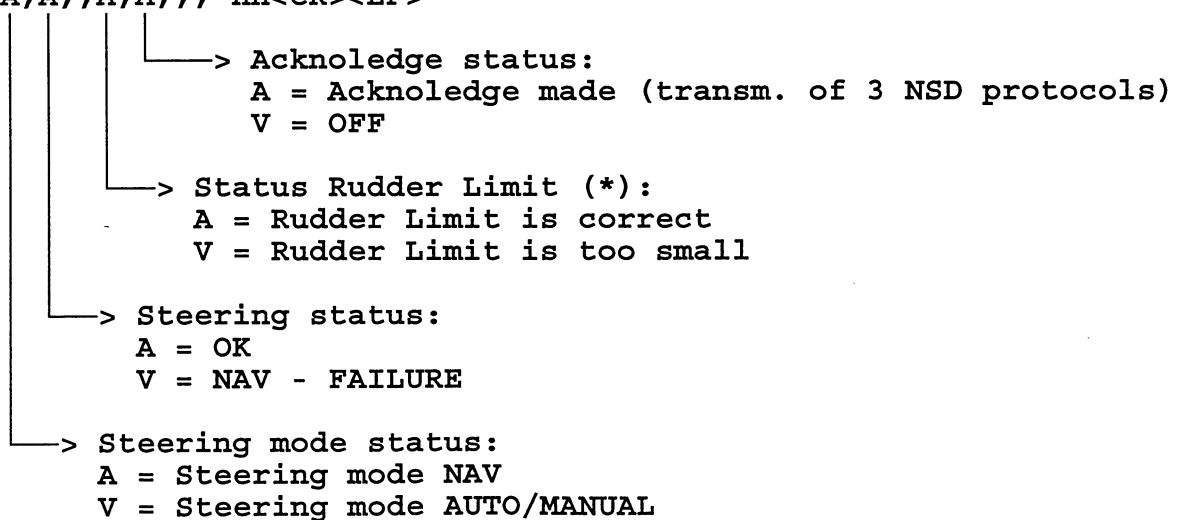



- * If the magnitude of RUDDER LIMIT on NAVIPILOT AD II is set to the necessary value, NAVIPILOT AD II confirms the RUDDER LIMIT by setting the status byte to 'A'.
If, during a track-course change, the ship does not reach the necessary turn rate for the radius transmitted from the INS and the turn rate ceases to increase, NAVIPILOT ADII will set the RUDDER LIMIT status byte to 'V'.

These protocols are transmitted continuously in the steering modes AUTO and NAV.



INS —> NAVIPILOT AD II
Driver : RS 422

Autopilot Sentence "B"

Transmission rate : 1 protocol per second

\$INAPB,A,A,x.x,a,N,A,A,x.x,a,,x.x,a,,*hh<CR><LF>

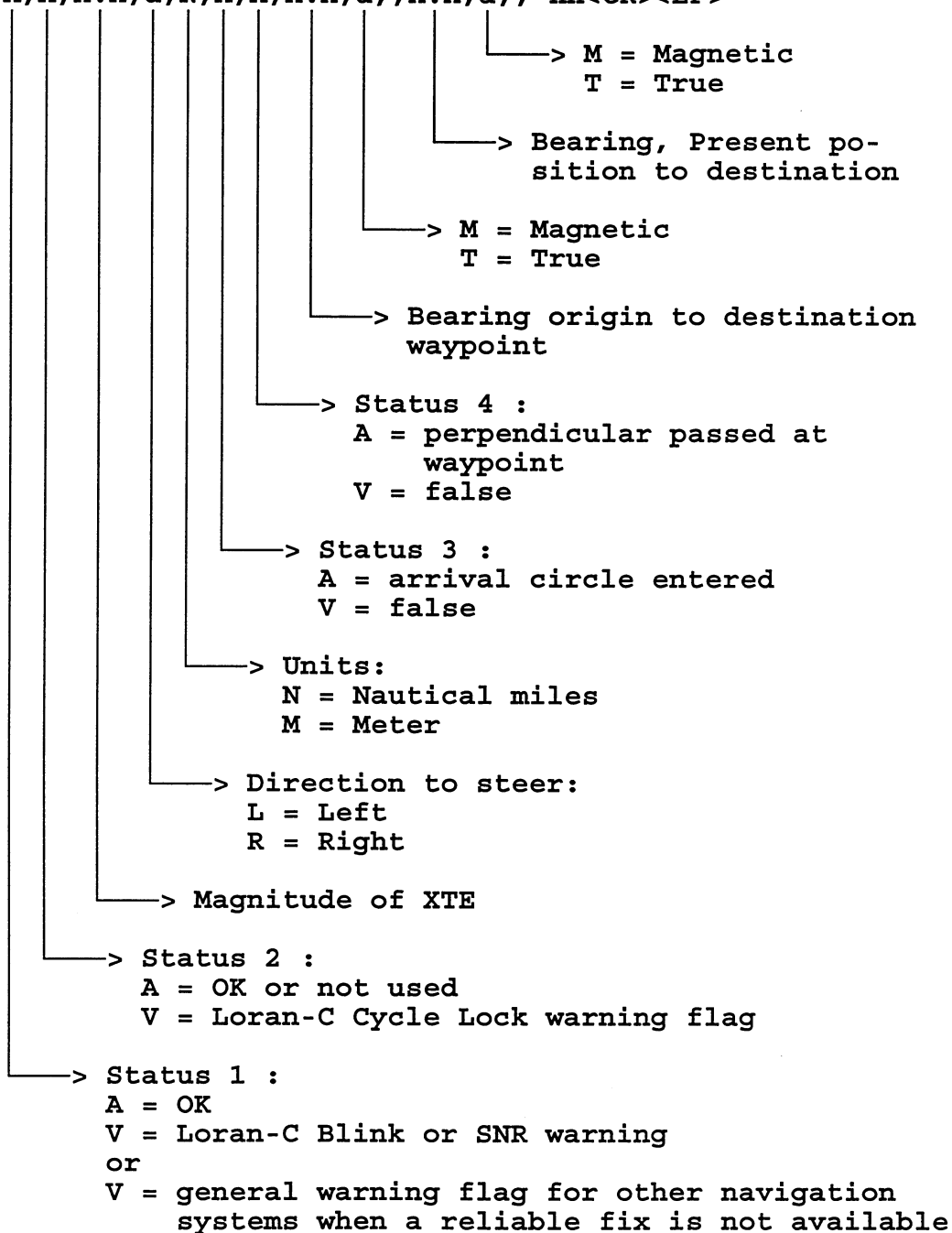



If GPS fails status byte 1 is set to 'V' and XTE is no longer available. In this case the 'bearing origin to destination waypoint' (track course) without XTE is used for 'NAV-SET-COURSE' of NAVIPILOT AD II.

Time to Wheel-Over Point

Transmission rate : 1 protocol per second

\$PPTTW,m.ss,A*hh<CR><LF>

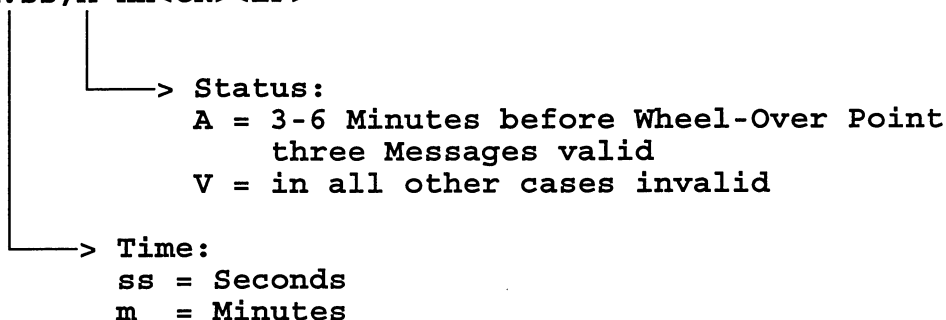

Radius

Transmission rate : 1 protocol per second

\$PPRDS,x.x,N,A*hh<CR><LF>

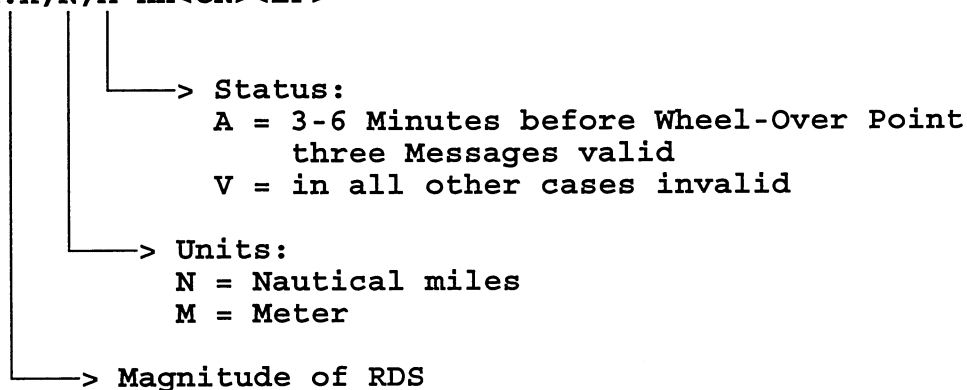



Navigation Status Data

Transmission rate : 1 protocol per second

\$PPNSD,,A,W,,,,*hh<CR><LF>

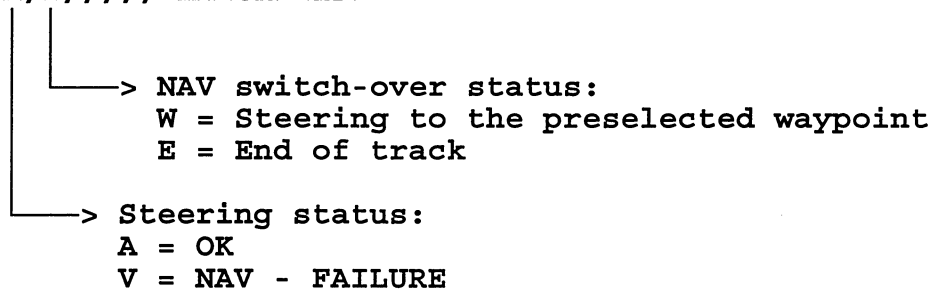

These protocols are transmitted continuously in steering mode NAV.



Serial - Interface - Specification

NAVIPILOT AD II <—> NAVIPILOT I

Baudrate : 4800 bps
Data bits : 8
Parity bits : none (disabled)
Stopbits : 1

Format : NMEA 0183

NAVIPILOT AD II —> NAVIPILOT I
Driver : RS 422

Autopilot System Data

Transmission rate : 1 protocol per second

\$AGASD,x.x,x.x,a,x.x,A,,,x.x,x,x,A*hh<CR><LF>

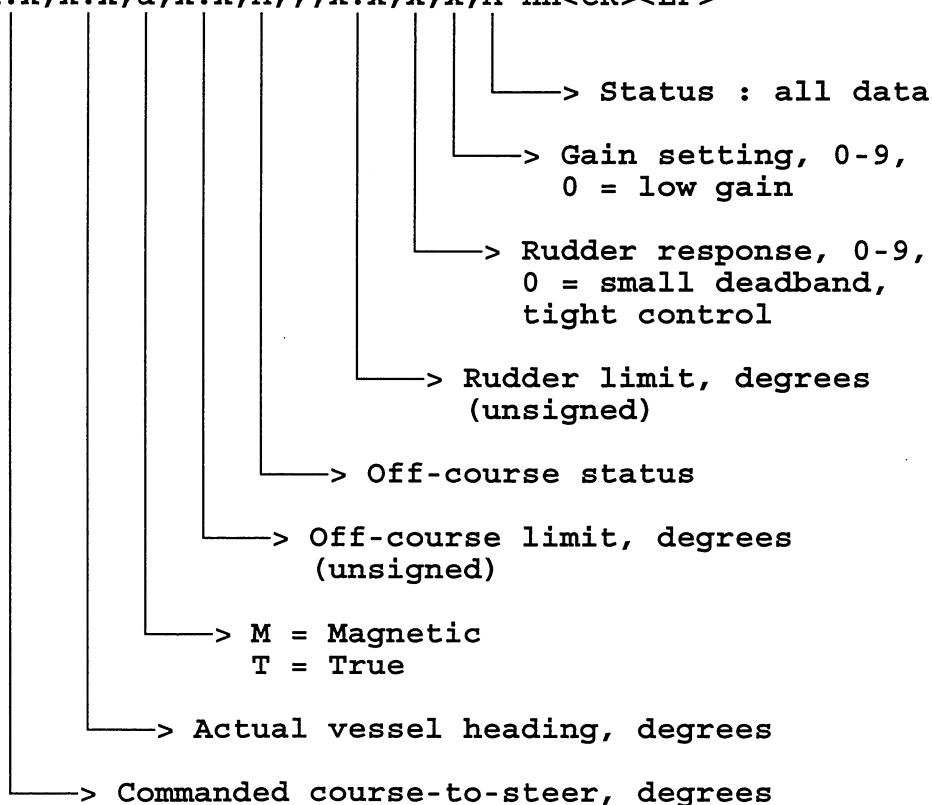



Navigation Status Data

Transmission rate : 1 protocol per second

\$PPNSD,A,A,,A,A,,,P*hh<CR><LF>

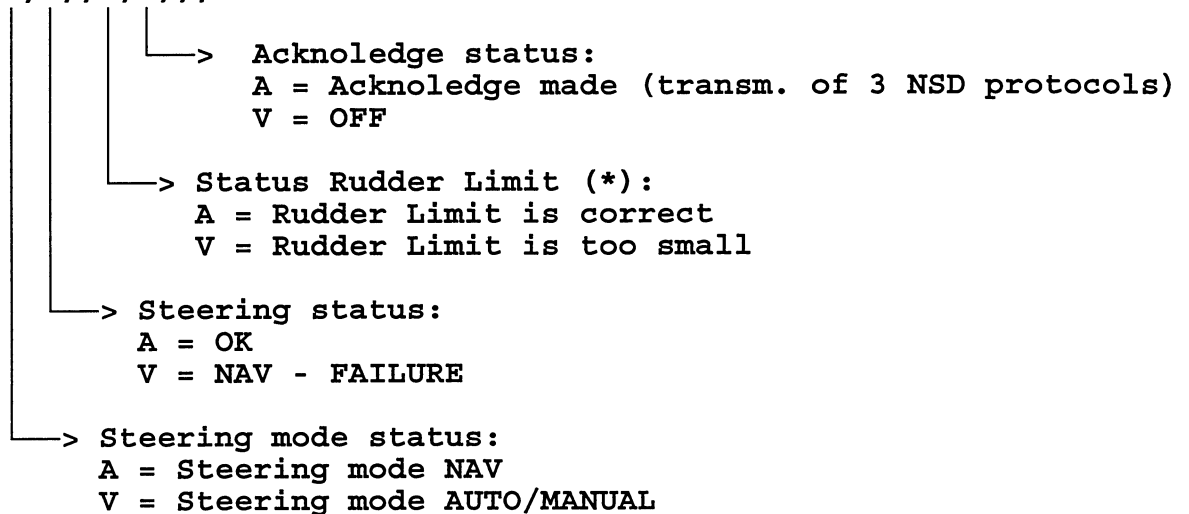

- * If the magnitude of RUDDER LIMIT on NAVIPILOT AD II is set to the necessary value, NAVIPILOT AD II confirms the RUDDER LIMIT by setting the status byte to 'A'.
If, during a track-course change, the ship does not reach the necessary turn rate for the radius transmitted from NAVIPILOT I and the turn rate ceases to increase, NAVIPILOT AD II will set the RUDDER LIMIT status byte to 'V'.

These protocols are transmitted continuously in the steering modes AUTO and NAV.



NAVIPILOT I —> NAVIPILOT AD II Driver : RS 422
--

Autopilot Sentence "B"

Transmission rate : 1 protocol per second

\$INAPB,A,A,x.x,a,N,A,A,x.x,a,,x.x,a,,*hh<CR><LF>

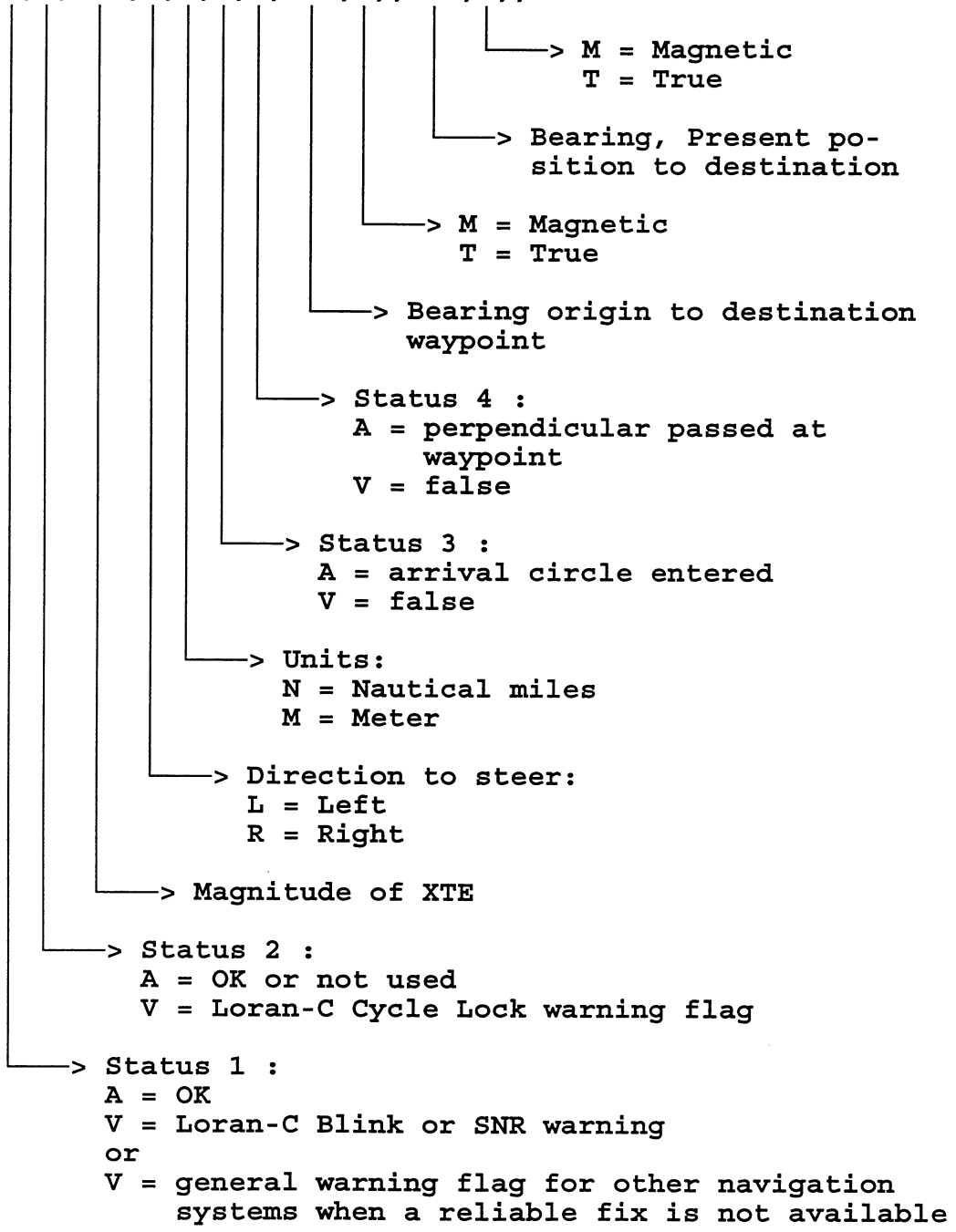



If GPS fails status byte 1 is set to 'V' and XTE is no longer available. In this case the 'bearing origin to destination waypoint' (track course) without XTE is used for 'NAV-SET-COURSE' of NAVIPILOT AD II.

Time to Wheel-Over Point

Transmission rate : 1 protocol per second

\$PPTTW,m.ss,A*hh<CR><LF>

> Status:
A = 3-6 Minutes before Wheel-Over Point
three Messages valid
V = in all other cases invalid

> Time:
ss = Seconds
m = Minutes

Radius

Transmission rate : 1 protocol per second

\$PPRDS,x.x,N,A*hh<CR><LF>

> Status:
A = 3-6 Minutes before Wheel-Over Point
three Messages valid
V = in all other cases invalid

> Units:
N = Nautical miles
M = Meter

> Magnitude of RDS



Navigation Status Data

Transmission rate : 1 protocol per second

\$PPNSD,,A,W,,,,,P*hh<CR><LF>

> NAV switch-over status:
W = Steering to the preselected waypoint
E = End of track

> Steering status:
A = OK
V = NAV - FAILURE

These protocols are transmitted continuously in steering mode NAV.



Serial - Interface - Specification

NAVIPILOT AD II <—> SELESMAR/VECTOR

Baudrate : 4800 bps
Data bits : 8
Parity bits : none (disabled)
Stopbits : 1

Format : NMEA 0183

NAVIPILOT AD II —> VECTOR
Driver : RS 422

Course to Steer

Transmission rate : 1 protocol per second

\$PRCTS,x,T,*CS<CR><LF>

└─> T = True
└─> Magnitude of CTS

Rate of Turn

Transmission rate : 1 protocol per second

\$PLROT,x.x,A,*CS<CR><LF>

└─> A = valid
 V = invalid
└─> Magnitude of ROT as set on the
 operation unit of NAVIPILOT AD II



Status Information

Transmission rate : 1 protocol per second

\$PLINF,A,I,G,*CS<CR><LF>

└───> 'G' , if NAVIPILOT AD II
 'T' , if VECTOR

These protocols are transmitted continuously in the steering modes AUTO and NAV.

VECTOR ────> NAVIPILOT AD II Driver : RS422

Precision Course to Steer

Transmission rate : 1 protocol per second

\$PRPCT,x.x,T*CS<CR><LF>

└───┬───> T = True
 └───> Magnitude of PCT

This protocol is transmitted continuously in the steering mode NAV.



Serial - Interface - Specification

NAVIPILOT AD II <—> NORCONTROL/DB2000

Baudrate : 4800 bps
Data bits : 8
Parity bits : none (disabled)
Stopbits : 1

Format : NMEA 0183

NAVIPILOT AD II —> DB2000
Driver : RS 422

Rate of Turn

Transmission rate : 1 protocol per second

\$PLROT,x.x,A,*CS<CR><LF>

> A = valid
V = invalid

> Magnitude of ROT as set on the
operation unit of NAVIPILOT AD II
in °/min

This protocol is transmitted continuously in all steering modes.



DB2000 —————> NAVIPILOT AD II Driver : RS422
--

Course to Steer

Transmission rate : 1 protocol per second

\$MLCTS,x.x,T*CS<CR><LF>

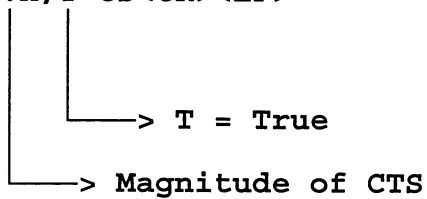

Turn Rate

Transmission rate : 1 protocol per second

\$MLHTR,-x.x,T*CS<CR><LF>

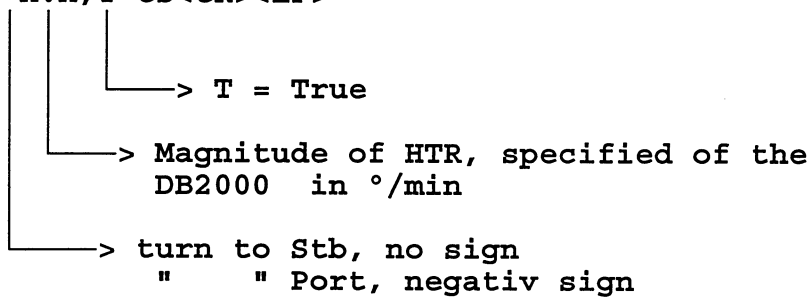

These protocols are transmitted continuously in the 'NAV' steering mode.